



ModCon Commercial Boilers

Installation

Start-Up

Maintenance

Parts

Warranty

MODCON1000 / 1700

"LP" Denotes Propane Gas Operation

"HL" Denotes Installed High and Low Gas Pressure Switches

"FS" Denotes Installed Flow Switch

"WL" Denotes Installed High Temperature Water Limit

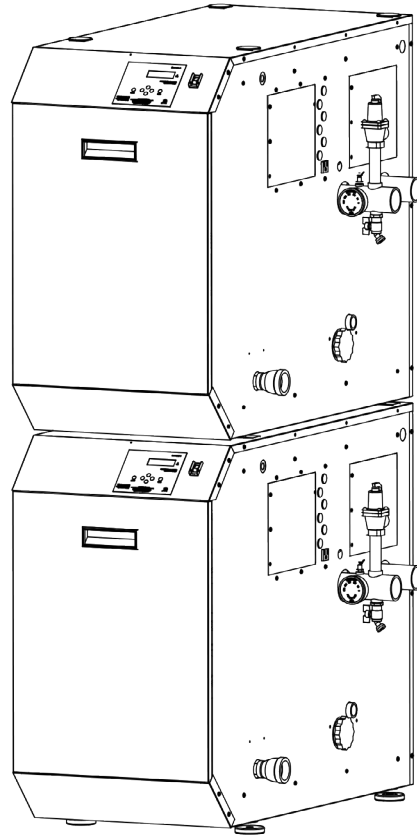

**This Manual For Use With Boilers Manufactured After
August 13, 2013**

Heat Exchanger Bears the ASME "H" Stamp



⚠ DANGER

This manual must only be used by a qualified installer / service technician. Read all instructions in this manual before installing. Perform steps in the given order. Failure to do so could result in substantial property damage, severe personal injury, or death.

⚠ WARNING

Improper installation, adjustment, alteration, service, or maintenance could void product warranty and cause property damage, severe personal injury, or death.

California Proposition 65 Warning: This product contains chemicals known to the State of California to cause cancer, birth defects, or other reproductive harm.

NOTICE

HTP reserves the right to make product changes or updates without notice and will not be held liable for typographical errors in literature.

NOTE TO CONSUMER: PLEASE KEEP ALL INSTRUCTIONS FOR FUTURE REFERENCE.

! WARNING

WARNING: If the information in these instructions is not followed exactly, a fire or explosion may result causing property damage, personal injury or death.

- Do not store or use gasoline or other flammable vapors and liquids in the vicinity of this or any other appliance.

WHAT TO DO IF YOU SMELL GAS

- Do not try to light any appliance.
- Do not touch any electrical switch; do not use any phone in your building.
- Immediately call your gas supplier from a neighbor's phone. Follow the gas supplier's instructions.
- If you cannot reach your gas supplier, call the fire department.
- Installation and service must be provided by a qualified installer, service agency or the gas supplier.

Improper installation, adjustment, alteration, service, or maintenance can cause injury, property damage, or death. Refer to this manual. Installation and service must be performed by a qualified installer, service agency, or gas supplier.

FOR YOUR SAFETY READ BEFORE OPERATING

WARNING: If you do not follow these instructions exactly, a fire or explosion may result, causing property damage, personal injury or loss of life.

- A. This appliance does not have a pilot. It is equipped with an ignition device which automatically lights the burner. Do not try to light the burner by hand.
- B. BEFORE OPERATING smell all around the appliance area for gas. Be sure to smell next to the floor because some gas is heavier than air and will settle on the floor.

WHAT TO DO IF YOU SMELL GAS

- Do not try to light any appliance
- Do not touch any electric switch; do not use any phone in your building
- Immediately call your gas supplier from a neighbor's phone. Follow the gas suppliers' instructions.

- If you cannot reach your gas supplier, call the fire department.
- C. Use only your hand to turn the gas control knob. Never use tools. If the handle will not turn by hand, don't try to repair it, call a qualified service technician. Force or attempted repair may result in a fire or explosion.
- D. Do not use this appliance if any part has been under water. Immediately call a qualified service technician to inspect the appliance and to replace any part of the control system and any gas control which has been under water.

OPERATING INSTRUCTIONS

- STOP! Read the safety information above.
- Set the thermostat to lowest setting.
- Turn off all electric power to the appliance.
- This appliance is equipped with an ignition device which automatically lights the burner. Do not try to light the burner by hand.
- Remove front cover.
- Turn gas shutoff valve to "off". Handle will be across the piping, do not force.
- Wait five (5) minutes to clear out any gas. If you then smell gas, STOP! Follow "B" in the safety information above on this label. If you don't smell gas, go to next step.
- Turn gas shutoff valve to "on". Handle will be in line with piping.
- Install Front Cover.
- Turn on all electric power to appliance.
- Set thermostat to desired setting.
- If the appliance will not operate, follow the instructions "To Turn Off Gas To Appliance" and call your service technician or gas supplier.

GAS VALVE
ON

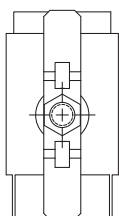

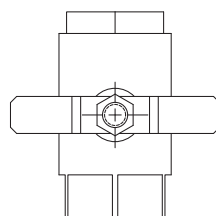

GAS VALVE
OFF



TO TURN OFF GAS TO APPLIANCE

- Set the thermostat to lowest setting.
- Turn off all electric power to the appliance if service is to be performed.
- Remove Front Cover.
- Turn gas shutoff valve to "off". Handle will be across the piping. Do not force.
- Install Front Cover.

LP-175 Rev. 4 3-11-08

SPECIAL ATTENTION BOXES	
The following defined terms are used throughout this manual to bring attention to the presence of hazards of various risk levels or to important product information.	
	DANGER
DANGER indicates an imminently hazardous situation which, if not avoided, will result in serious personal injury or death.	
	WARNING
WARNING indicates a potentially hazardous situation which, if not avoided, could result in personal injury or death.	
	CAUTION
CAUTION indicates a potentially hazardous situation which, if not avoided, may result in moderate or minor personal injury.	
CAUTION	
CAUTION used without the safety alert symbol indicates a potentially hazardous situation which, if not avoided, may result in property damage.	
NOTICE	
NOTICE is used to address practices not related to personal injury.	

Foreword

This manual is intended to be used in conjunction with other literature provided with the boiler. This includes all related control information. It is important that this manual, all other documents included in this system, and additional publications including the *National Fuel Gas Code - ANSI Z223.1* (latest versions), be reviewed in their entirety before beginning any work.

Installation should be made in accordance with the regulations of the Authority Having Jurisdiction, local code authorities, and utility companies which pertain to this type of water heating equipment.

Authority Having Jurisdiction (AHJ) – The AHJ may be a federal, state, local government, or individual such as a fire chief, fire marshal, chief of a fire prevention bureau, labor department or health department, building official or electrical inspector, or others having statutory authority. In some circumstances, the property owner or his/her agent assumes the role, and at government installations, the commanding officer or departmental official may be the AHJ.

NOTE: HTP reserves the right to modify product technical specifications and components without prior notice.

For the Installer

This boiler must be installed by qualified and licensed personnel. The installer should be guided by the instructions furnished with the boiler, and by local codes and utility company requirements. In the absence of local codes, preference should be given to the *National Fuel Gas Code - ANSI Z223.1*, latest version.

Installations Must Comply With:

Local, state, provincial, and national codes, laws, regulations, and ordinances.

The latest version of the *National Fuel Gas Code, ANSI Z223.1*, from American Gas Association Laboratories, 8501 East Pleasant Valley Road, Cleveland, OH 44131.

In Canada - *CGA No. B149* (latest version), from Canadian Gas Association Laboratories, 55 Scarsdale Road, Don Mills, Ontario, Canada M3B 2R3. Also, *Canadian Electrical Code, C 22.1*, from Canadian Standards Association, 5060 Spectrum Way, Suite 100, Mississauga, Ontario, Canada L4W 5N6.

The latest version of the *National Electrical Code, NFPA No. 70*.

NOTE: The gas manifold and controls met safe lighting and other performance criteria when undergoing tests specified in *ANSI Z21.13* - latest edition.

⚠ DANGER

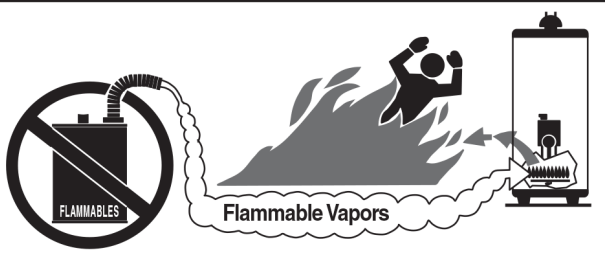

⚠ Vapors from flammable liquids will explode and catch fire causing death or severe burns.
Do not use or store flammable products such as gasoline, solvents or adhesives in the same room or area near the water heater.
Keep flammable products:
1. far away from heater,
2. in approved containers,
3. tightly closed and
4. out of children's reach.

Installation:
Do not install water heater where flammable products will be stored or used unless the main burner and pilot flames

Water heater has a main burner and pilot flame.
The pilot flame:
1. which can come on at any time and
2. will ignite flammable vapors.
Vapors:
1. cannot be seen,
2. are heavier than air,
3. go a long way on the floor and
4. can be carried from other rooms to the pilot flame by air currents.

are at least 18" above the floor. This will reduce, but not eliminate, the risk of vapors being ignited by the main burner or pilot flame.

Read and follow water heater warnings and instructions. If owners manual is missing, contact the retailer or manufacturer.

⚠ DANGER



Water temperature over 125°F can cause severe burns instantly or death from scalds.
Children, disabled and elderly are at highest risk of being scalded.
See instruction manual before setting temperature at water heater.
Feel water before bathing or showering.
Temperature limiting valves are available, see manual.

NOTICE

The CSD-1 ASME Code, Section CW-400 requires that hot water heating and supply boilers have a) a UL 353 temperature control device, b) at least one (1) temperature-actuated control to shut off the fuel supply when system water reaches a preset operating temperature, c) a high temperature limit control that prevents the water temperature from exceeding the maximum allowable temperature by causing a safety shutdown and lockout, and d) its own sensing element and operating switch.

The temperature control system integrated into the 926 control provided with this heating appliance complies with the requirements of CSD-1 Section CW-400 as a temperature operation control. The control monitors the temperature difference between the inlet and the outlet sensor, which is affected by boiler water flow. If this temperature difference exceeds 55°F (typically because of low water flow or very low heat load), the control will reduce the maximum fan speed. If the temperature difference exceeds 60°F, the control will effectively sense there is little or no water flow or heat load and shut the boiler down. The controller will restart automatically once the temperature difference has dropped below 55°F and the minimum off time (anti-cycle time) has expired. In addition, if the control senses that the outlet water temperature has reached 210°F, the boiler is put into a hard lockout and requires manual reset to restart.

IMPORTANT

In accordance with Section 325 (f) (3) of the Energy Policy and Conservation Act, HTP has provided this boiler with multiple features designed to save energy by reducing the boiler water temperature as heating load decreases.

These features include:

- **A modulating combustion system that adjusts firing rate based on heat demand.**
- **Adjustment of boiler set point based on inferred heat load as determined by an outdoor sensor. The outdoor sensor is supplied by HTP with this boiler.**
- **This boiler does not include a standing pilot.**
- **This boiler is designed and shipped to assure the highest efficiency operation possible. Such high efficiency is achieved by limiting heating circuit water temperature to 140°F when there is no anticipated heat load, based upon the outdoor sensor and the Outdoor Reset Curve (sensor response curve) in the boiler software.**
- **This feature may be over-ridden as described below in specific installations:**
- **The boiler control is equipped with an outdoor sensor override for use with building management systems or in cascaded systems (for systems with total input of 300,000 BTU/hr or greater).**

See statement below for an important notice on the use of the override.

IMPORTANT

In accordance with Section 325 (f) (3) of the Energy Policy and Conservation Act, this boiler is equipped with a feature that saves energy by reducing the boiler water temperature as the heating load decreases. This feature is equipped with an override which is provided primarily to permit the use of an external energy management system that serves the same function. THIS OVERRIDE MUST NOT BE USED UNLESS AT LEAST ONE OF THE FOLLOWING CONDITIONS IS TRUE:

- **An external energy management system is installed that reduces the boiler water temperature as the heating load decreases.**
- **This boiler is not used for space heating.**
- **This boiler is part of a modular or multiple boiler system having a total input of 300,000 BTU/hr or greater.**
- **This boiler is equipped with a tankless coil.**

WARNING

The hydronic supply and return connections of these products are for installation in closed loop systems ONLY! Use of this product in any manner other than described in this manual may result in premature product failure, substantial property damage, severe personal injury, or death. Damage or failure of this product (or the system in which it is installed) due to unauthorized use IS NOT COVERED BY WARRANTY.

Table of Contents

Part 1 - General Safety Information	5
A. Improper Combustion	6
B. Gas	6
C. When Servicing the Water Heating System	6
D. Boiler Water	6
E. Freeze Protection	6
F. High Elevation Installations	6
Part 2 - Before You Start	6
A. What's in the Box	6
B. How the Boiler Operates	6
C. Optional Equipment	7
Part 3 - Prepare the Boiler	7
A. Locating the Boiler	7
B. Flooring	8
C. Leveling	8
D. Clearances for Service Access	8
E. Residential Garage and Closet Installations	9
F. Exhaust Vent and Intake Pipe	9
1. Direct Vent of Exhaust and Intake	10
2. Indoor Combustion Air in Confined or Unconfined Space	10
G. Carbon Monoxide Detectors	10
H. Prevent Combustion Air Contamination	10
I. Removing a Boiler from a Common Vent System	11
J. Water Chemistry Requirements*	11
K. Technical Specifications	13
Part 4 - Piping	14
A. General Plumbing Information	14
B. Relief Valve	14
C. Backflow Preventer	14
D. Expansion Tank	14
E. Circulators	15
F. Hydronic Piping with Circulators, Zone Valves, and Multiple Boilers	15
G. Circulator Sizing	15
H. Check / Control Water Chemistry	17
I. Plumbing	17
J. Fill and Purge Heating System	17
K. Freeze Protection Fluids	18
L. Zoning with Zone Valves	18
M. Zoning with Circulators	18
N. Multiple Boilers	18
O. Applications	19
Part 5 - Venting	23
A. General	23
B. Approved Materials for Exhaust Vent and Intake Pipe	24
C. Additional Requirements for Installation in Canada	24
D. Exhaust Vent and Intake Pipe Location	25
E. Exhaust Vent and Intake Pipe Sizing	26
F. Exhaust Vent and Intake Pipe Installation	26
G. Applications	27
1. Direct Vent Installation of Exhaust and Intake	27
2. Room and Indoor Combustion Ventilation Requirements	29
Part 6 - Condensate Removal	30
Part 7 - Wiring	31
A. Installation Must Comply With	31
B. Field Wiring Terminations	31
C. Field Wiring	31

D. Line Voltage Wiring 31
E. Alarm Connections (Top Boiler Connection) 32
F. Low Voltage Connections for Standard Boiler 32
G. Thermostat 32
H. Outdoor Sensor 32
I. Indirect Sensor (Top Boiler Connection) 32
J. Optional 0-10 Volt Building Control Signal 32
K. Optional High Gas Pressure Switch 32
L. Optional Low Gas Pressure Switch 32
M. Optional Flow Switch 33
N. Optional UL353 Low Water Cut-Off Interface Kit 34
O. Wiring of Cascade System Communication Bus 35

Part 8 - Gas Connections 35
A. Gas Piping 36
B. Gas Table 37
C. Check Inlet Gas Pressure 37
D. Boiler Gas Valve 38

Part 9 - Start-Up Preparation 39
A. Check / Control Water Chemistry 39
B. Check for Gas Leaks 39
C. Freeze Protection (When Used) 39
D. Condensate Removal 39
E. Fill and Test Water System 40
F. Purge Air from Water System 40
G. Check Thermostat Circuit(s) 40
H. Condensate Removal 40
I. Final Checks Before Starting Boiler 40
J. Cascade System - 1000 and 1700 Models 41

Part 10 - Start-Up Procedure 41
A. Control Overview 41
B. Navigation of the Display 41
C. Operating Instructions 42
D. Programming Boiler Settings 42
E. Programming the System Setting 43
F. System Setting Program Navigation 43
G. Resetting the Maintenance Schedule 45

Part 11 - Start-Up Procedures for the Installer 45
A. Boiler Control Status Menu 45
B. Cascade Menu 47
C. Boiler Test Mode 48

Part 12 - Troubleshooting 48
A. Boiler Error and Fault Codes 48
B. Boiler Error 48
C. Boiler Fault 48
D. User Interface Display 49

Part 13 - Maintenance 54
A. Procedures 54
B. Combustion Chamber Coil Cleaning Instructions 54
C. Cleaning Water Side of Heat Exchanger 55

Part 14 - Installation Checklist 56
Part 15 - Maintenance Report 56
Part 16 - Replacement Parts 58
Limited Warranty 63
Maintenance Notes 65
Customer Installation Record Form 66

Part 1 - General Safety Information

This boiler is approved for indoor installations only. Clearance to combustible materials: 0" top, bottom, sides, and back. Left side has all boiler mechanical connections. Boiler must have room for service: 24" front is minimum recommended service clearance. (A combustible door or removable panel is acceptable front clearance.) This boiler has been approved for closet installation and installation on combustible flooring. Do not install directly on carpeting. Install the boiler in a location where temperature and pressure relief valve discharge or a leak will not result in damage to the surrounding area. Use only Category IV vent systems.

WARNING

Installer - Read all instructions in this manual before installing. Perform steps in the given order.

User - This manual is for use only by a qualified heating installer / service technician. Have this boiler serviced / inspected annually by a qualified service technician.

FAILURE TO ADHERE TO THE GUIDELINES ON THIS PAGE CAN RESULT IN SUBSTANTIAL PROPERTY DAMAGE, SEVERE PERSONAL INJURY, OR DEATH.

NOTE: If the boiler is exposed to the following, do not operate. Immediately call a qualified service technician.

1. Fire
2. Damage
3. Water

Failure to follow this information could result in property damage, severe personal injury, or death.

DO NOT USE THIS BOILER IF ANY PART HAS BEEN SUBMERGED IN WATER. Immediately call a qualified service technician. The boiler **MUST BE** replaced if it has been submerged. Attempting to operate a boiler that has been submerged could create numerous harmful conditions, such as a potential gas leakage causing a fire and/or explosion, or the release of mold, bacteria, or other harmful particulates into the air. Operating a previously submerged boiler could result in property damage, severe personal injury, or death.

NOTE: Boiler damage due to flood or submersion is considered an Act of God, and IS NOT covered under product warranty.

NOTE: Obey all local codes. Obtain all applicable permits before installing the boiler.

NOTE: Install all system components and piping in such a manner that does not reduce the performance of any fire rated assembly.

Altering any HTP boiler with parts not manufactured by HTP **WILL INSTANTLY VOID** the boiler warranty and could result in property damage, personal injury, or death.

CAUTION

Do not use this boiler for anything other than its intended purpose (as described in this manual). Doing so could result in property damage and **WILL VOID** product warranty.

High heat sources (sources generating heat 100°F / 37°C or greater, such as stove pipes, space heaters, etc.) may damage plastic components of the boiler as well as plastic vent pipe materials. Such damages **ARE NOT** covered by warranty. It is recommended to keep a minimum clearance of 8" from high heat sources. Observe heat source manufacturer instructions, as well as local, state, provincial, and national codes, laws, regulations and ordinances when installing this boiler and related components near high heat sources.

Due to low water content of the boiler, improperly sizing the boiler in regard to potable water heating load will result in excessive boiler cycling and accelerated component failure. HTP **DOES NOT** warrant failures caused by improperly sized boiler applications. **DO NOT** oversize the boiler to the system. Modular boiler installations greatly reduce the likelihood of boiler oversizing.

A. Improper Combustion

WARNING

Do not obstruct the flow of combustion and ventilating air. Adequate air is necessary for safe operation. Failure to keep the exhaust vent and combustion air intake clear of ice, snow, or other debris could result in property damage, serious personal injury, or death.

B. Gas

Should overheating or gas supply fail to shut off, turn off the manual gas control valve to the boiler.

C. When Servicing the Water Heating System

WARNING

Be sure to disconnect electrical power before opening boiler cabinet or performing service. Failure to do so could result in electrical shock, property damage, serious personal injury, or death.

To avoid electric shock, disconnect electrical supply before performing maintenance.

NOTE: When inquiring about service or troubleshooting, reference the model and serial numbers from the boiler rating label.

To avoid severe burns, allow boiler and associated equipment to cool before servicing.

D. Boiler Water

- If you have an old system with cast iron radiators, thoroughly flush the system (without boiler connected) to remove sediment. The high-efficiency heat exchanger can be damaged by build-up or corrosion due to sediment. HTP recommends a suction strainer in this type of system.
- Do not use petroleum-based cleaning or sealing compounds in boiler system. Gaskets and seals in the system may be damaged, possibly resulting in substantial property damage.
- Do not use "homemade cures" or "boiler patent medicines". Substantial property damage, damage to boiler, and/or serious personal injury may result.
- Continual fresh make-up water will reduce boiler life. Mineral buildup in the heat exchanger reduces heat transfer, overheats the stainless steel heat exchanger, and causes failure. Addition of oxygen from make-up water can cause internal corrosion in system components. Leaks in the boiler or piping must be repaired at once.
- **NOTE:** DO NOT add cold make up water to the system when the boiler is hot. Thermal shock can potentially cause cracks in the heat exchanger. Such damage IS NOT covered by warranty.

E. Freeze Protection

NOTE: Consider piping and installation when determining boiler location.

CAUTION

Failure of the boiler due to freeze related damage IS NOT covered by product warranty.

WARNING

NEVER use any toxic chemical, including automotive, standard glycol antifreeze, or ethylene glycol made for hydronic (non-potable) systems. These chemicals can attack gaskets and seals in water systems, are poisonous if consumed, and can cause personal injury or death.

F. High Elevation Installations

WARNING

Natural gas at high elevation might contain less heating value than typical 1,000 BTU/cu ft and therefore can cause improper air / gas mix leading to improper combustion. For natural gas installations above 3,000 ft, call your gas provider to determine the heating value of the supplied natural gas.

Part 2 - Before You Start

A. What's in the Box

Remove all sides of the shipping crate of the boiler.

Components included with the boiler:

- Temperature and Pressure Gauge
- Outdoor Sensor
- Installation Manual and Warranty
- User's Information Manual
- CSD-1 Form
- H-3 Data Sheet

B. How the Boiler Operates

Mod Con boilers are designed to meet the needs of the most challenging new and retrofit installations. Mod Con 1000 and 1700 models incorporate two individual heating systems that are piped, wired, and programmed to work as one, providing built-in system redundancy and maximum turndown and efficiency. Outlined below are features of the system and how each operates.

Stainless Steel Heat Exchanger

The highly efficient stainless steel heat exchanger is designed to use the cold water return from the system and extract the last bit of heat before it is exhausted.

Modulating Combustion System

The combustion system modulates the output of the burner during operation to match system demand and achieve the control set point while in operation. The set point can change by internal or external signals to enhance the overall performance of the system.

Control

The integrated control system monitors the system and regulates fan speed, controlling the output of each boiler and staging the individual heating circuits to maximize overall efficiency. This allows the Mod Con to deliver only the amount of heat energy required and nothing more. The system can be further enhanced by installing with an indirect water heater to provide domestic hot water.

The control can regulate the output of multiple boilers through its cascade system function. The cascade system is capable of connecting up to eight boilers together in such a way that they function as one boiler system. This allows for greater turn down ratios and provides systematic control of the multiple boilers in an installation to minimize downtime and maximize efficiency.

The cascade system works by establishing one boiler as the master and the other connected boilers as followers. The master boiler requires a cascade system sensor and a cascade pump in addition to its own boiler pump. Each of the follower boilers has an individual pump.

Text Display and Operational LED Light Indicators

The display allows the user to change system parameters and monitor system outputs.

Gas Valve

Senses suction from the blower, allowing gas to flow only if powered and combustion air is flowing.

Integrated Venturi (1000 Models) or Swirl Plate (1700 Models)

Controls air and gas flow into the burner.

Burner

The high grade stainless steel burner uses premixed air and gas to provide a wide range of firing rates.

Spark Ignition

The burner is ignited by applying high voltage through the system spark electrode. The spark from the electrode ignites mixed gas off of the burner.

Supply Water Temperature Sensor

This sensor monitors the boiler outlet water temperature (System Supply). The control adjusts boiler firing rate so the supply temperature will match the boiler set point.

Return Water Temperature Sensor

This sensor monitors boiler return water temperature (System

Return).

System Sensor

This sensor is mounted in the boiler common piping and monitors the water temperature of the outlet of both boilers simultaneously. The master boiler uses this sensor as its primary feedback to control the outlet water temperature of a cascaded boiler system.

NOTE: When using a system sensor, pipe insulation must be wrapped around it to improve temperature measurement accuracy and increase overall system efficiency.

Temperature and Pressure Gauge

Allows the user to monitor system temperature and pressure.

Electrical field connections with terminal strips

The electrical cover allows easy access to the clearly marked line voltage and low voltage terminal strips to facilitate wiring the boiler.

Condensate Collection System

This boiler is a high efficiency appliance and will produce condensate. The condensate collection system has a float switch which monitors condensate level and prevents condensate from backing up into the combustion system. Inside the collection system is a built in trap which seals the combustion system from the connected drain. This condensate should be neutralized to avoid damage to the drainage system or piping.

0-10 Volt Input

Allows the installer to connect a BMS (Building Management System) to control the boiler.

Integrated System Sensor

The system sensor measures the temperature of return water and communicates with the control system to modulate the firing rate of the connected boilers.

Outdoor Sensor

This sensor monitors outdoor temperature. Data from this sensor is monitored by the control, which adjusts the boiler set point to provide greater efficiency.

Flow Protection (optional)

The optional flow switch is designed to protect the boiler in the event of low flow conditions. The boiler control also monitors flow through the heat exchanger by monitoring the return and supply sensors and will shut down the burner before overheating occurs.

Indirect Tank Sensor (optional)

Monitors storage tank temperature.

C. Optional Equipment

Optional equipment available from HTP (and Part #):

- Remote System Sensor (7250P-324)
- Indirect Tank Sensor (7250P-325)
- 6" Stainless Steel Vent Termination Kit (V3000)
- High and Low Gas Pressure Switch Kit with Manual Reset (7350P-600 - Two [2] are Required)
- UL 353 Compliant Low Water Cut-Off Interface Kit with Manual Reset (7350P-601 - Two [2] are Required)
- Alarm System (to monitor any failure) (7350P-602 - Top Boiler Only)
- PC Connection Kit (7250P-320)
- Condensate Neutralizer (7350P-611)
- Caster Kit (7350p-227)
- Flow Switch Kit (7350P-605 - Two [2] are Required)
- Stainless to PVC Vent Adapter (6" - 7350P-275, 8" - 7350P-375)
- Intake and Exhaust Screens (6" - SSV6.6, 8" - SSV8.6)

Part 3 - Prepare the Boiler

Remove all sides of the shipping crate to allow the boiler to be moved into its installation location. The boiler is also equipped with leveling feet that can be used to level the boiler properly on an uneven location surface. If surface flooring is rough, take care when moving the boiler into position, as catching the leveling feet could damage the boiler.

CAUTION

COLD WEATHER HANDLING - If the boiler has been stored in a very cold location (BELOW 0°F) before installation, handle with care until the components come to room temperature. Failure to do so could result in damage to the boiler.

Carefully consider installation when determining boiler location. Please read the entire manual before attempting installation. Failure to properly take factors such as boiler venting, piping, condensate removal, and wiring into account before installation could result in wasted time, money, and possible property damage and personal injury.

A. Locating the Boiler

WARNING

This boiler is certified for indoor use only. DO NOT INSTALL OUTDOORS. Outdoor installations ARE NOT covered by warranty. Failure to install the boiler indoors could result in property damage, severe personal injury, or death.

Incorrect ambient conditions can lead to damage to the heating system and put safe operation at risk. Ensure that the installation location adheres to the information included in this manual. Failure to do so could result in property damage, serious personal injury, or death. Failure of boiler or components due to incorrect operating conditions IS NOT covered by product warranty.

This boiler must be installed upright in the vertical position as described in this manual. DO NOT attempt to install this boiler in any other orientation. Doing so will result in improper boiler operation and property damage, and could result in serious personal injury or death.

1. Installation Area (Mechanical Room) Operating Conditions

- Ensure ambient temperatures are higher than 32°F / 0°C and lower than 104°F / 40°C
- Prevent the air from becoming contaminated by the products, places, and conditions listed in this manual
- Avoid continuously high levels of humidity
- Never close existing ventilation openings
- Ensure a minimum 1" clearance around hot water and exhaust vent pipes
- NOTE: To prevent condensing in the fan, it is recommended to avoid prolonged exposure to temperatures below 45°F

WARNING

This boiler has a condensate disposal system that may freeze if exposed to sustained temperatures below 32°F. Precautions should be taken to protect the condensate trap and drain lines from sustained freezing conditions. Failure to take precautions could result in property damage, severe personal injury, or death.

2. Check for nearby connections to:

- System water piping
- Venting connections
- Gas supply piping
- Electrical power
- Condensate drain

3. Check area around boiler. Remove any combustible materials, gasoline, and other flammable liquids.

▲ WARNING

Failure to keep the boiler area clear and free of combustible materials, liquids, and vapors can result in substantial property damage, severe personal injury, or death.

CAUTION

The service life of the boiler's exposed metallic surfaces, such as the casing, as well as internal surfaces, such as the heat exchanger, are directly influenced by proximity to damp and salty marine environments. In such areas higher concentration levels of chlorides from sea spray coupled with relative humidity can lead to degradation of boiler components. In these environments, boilers must not be installed using direct vent systems which draw outdoor air for combustion. Such boilers must be installed using room air for combustion. Indoor air will have a much lower relative humidity, and hence potential corrosion will be minimized.

High heat sources (generating heat 100°F / 37°C or greater, such as boiler flue pipes, space heaters, etc.) may damage plastic components of the boiler as well as plastic vent pipe materials. Such damages ARE NOT covered by warranty. It is recommended to keep a minimum clearance of 8" from high heat sources. Observe heat source manufacturer instructions, as well as local, state, provincial, and national codes, laws, regulations, and ordinances when installing this boiler and related components near high heat sources.

Failure of the boiler or components due to incorrect operating conditions IS NOT covered by product warranty.

4. Gas control system components must be protected from dripping water during operation and service.

5. If the boiler is to replace an existing boiler, check for and correct any existing system problems, such as:

- System leaks
- Location that could cause the system and boiler to freeze and leak
- Incorrectly sized expansion tank

6. Clean and flush system when reinstalling a boiler.

NOTE: This boiler must be installed within the prescribed clearances. If local building codes require additional clearance, these codes supersede HTP's. It is recommended to make note of the boiler model and serial number before finalizing installation.

▲ WARNING

The boiler is extremely heavy. Use extreme care not to drop the boiler or cause bodily injury while lifting. Failure to follow these instructions could result in property damage, severe personal injury, or death.

Gas conversion should be performed BEFORE the boiler is installed. Carefully follow the gas conversion instructions when performing the conversion. Failure to follow these instructions could result in property damage, severe personal injury, or death.

B. Flooring**▲ WARNING**

Assure that the floor and structure of the installation location are sufficient to support the full installed weight of the boiler, including water content of the heat exchanger and related piping. Failure to ensure the floor and structure of the installation location are structurally sound before installation of the boiler can result in structural failure, substantial property damage, severe personal injury, or death.

▲ WARNING

This boiler is approved for installation on combustible flooring, but must never be installed on carpeting. Installing this boiler on carpeting could result in fire, property damage, severe personal injury, or death.

C. Leveling**▲ CAUTION**

In order for the condensate to properly flow out of the collection system, the area where you locate the boiler must be level. Location must also fully support the weight of the filled boiler.

NOTE: It is recommended that the boiler be installed on a 4 - 6" raised boiler pad rated for the weight of the fully operational boiler and related piping. If flooding is a concern, it is recommended to further elevate the boiler pad to prevent water from reaching the boiler.

D. Clearances for Service Access

NOTE: If you do not provide the minimum clearances shown in Figure 2 it might not be possible to service the boiler without removing it from the space.

NOTE: A combustible door or removable panel is acceptable front clearance.

▲ WARNING

The space must be provided with combustion / ventilation air openings correctly sized for all other appliances located in the same space as the boiler. The boiler cover must be securely fastened to prevent the boiler from drawing air from the boiler room. This is particularly important if the boiler is in a room with other appliances. Failure to comply with the above warnings could result in substantial property damage, severe personal injury, or death.

CAUTION

All boilers eventually leak. Locate the boiler where any leakage from the relief valve, related piping, tank, or connections will not result in damage to surrounding areas or lower floors of the building. Any boiler should be installed in such a manner that if it should leak the resulting flow of water will not cause damage to the area in which it is installed. If the boiler is installed in a location where a leak could cause damage, it is required to provide containment measures. Such measures include but are not limited to: a properly sized drain pan installed beneath the boiler and piped to an open drain line, or installing the boiler on a concrete floor pitched to a free flowing drain. Failure to provide containment measures is the sole responsibility of the owner and/or installer. Leakage damages ARE NOT covered by warranty. In addition, water leak detection devices and automatic water shutoff valves are readily available at plumbing supply houses. IT IS HIGHLY RECOMMENDED BY THE MANUFACTURER TO INSTALL WATER LEAK DETECTION DEVICES AND AUTOMATIC SHUTOFF VALVES IN ANY BOILER INSTALLATION WHERE A LEAKAGE OF WATER COULD RESULT IN PROPERTY DAMAGES.

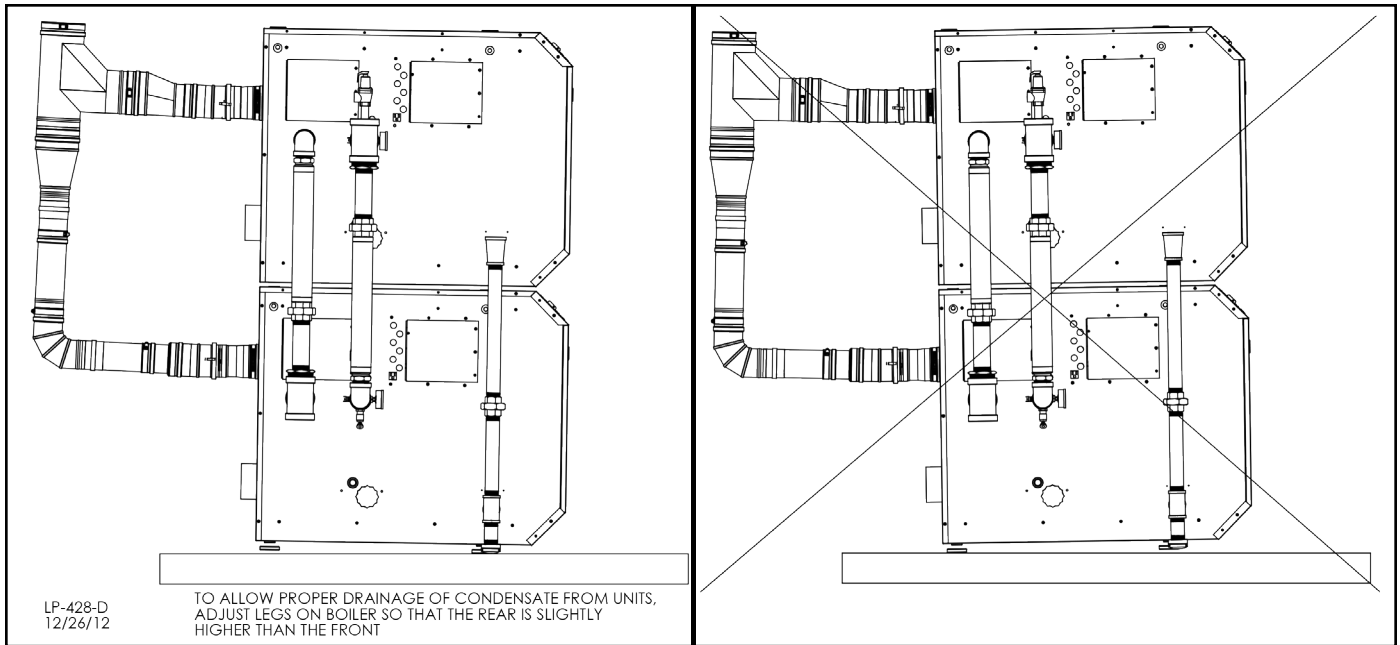

Figure 1 - Correct and Incorrect Leveling

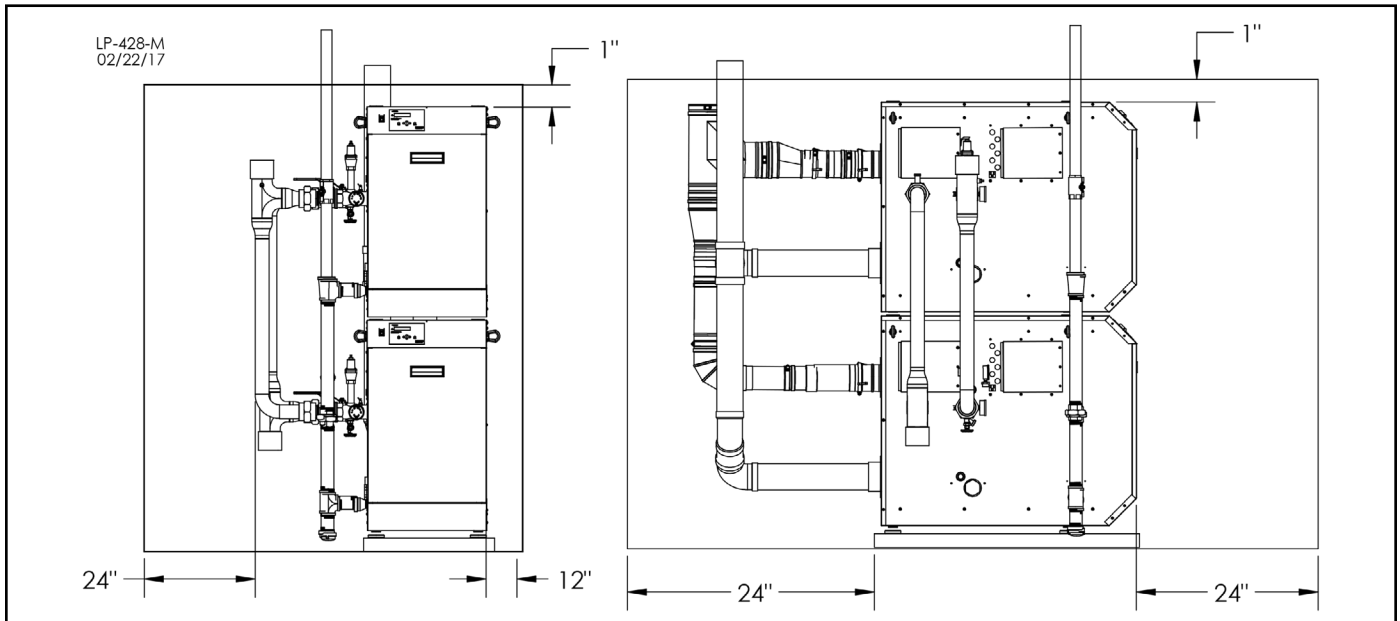

Figure 2 - Recommended Service Clearances

E. Residential Garage and Closet Installations

CAUTION

Check with your local Authority Having Jurisdiction for requirements when installing the boiler in a garage or closet. Please read the entire manual before attempting installation. Failure to properly take factors such as venting, piping, condensate removal, and wiring into account before installation could result in wasted time, money, and possible property damage and personal injury.

Precautions

- If the boiler is located in a residential garage, per ANSI Z223.1:
- Install the boiler burner and ignition devices a minimum of 18" above the floor of the garage. This will ensure the burner and ignition devices are well off the floor.
 - When raising the boiler ensure the entire bottom and fully filled weight of the boiler are fully supported.
 - Locate or protect the boiler so it cannot be damaged by a moving vehicle.



WARNING

The space must be provided with correctly sized combustion/ventilation air openings for all other appliances located in the space with the boiler. For power venting installations using room air for combustion, refer to the venting section, this manual, for descriptions of confined and unconfined spaces. Do not install the boiler in an attic. Failure to comply with these warnings could result in substantial property damage, severe personal injury, or death.

F. Exhaust Vent and Intake Pipe

The boiler is rated ANSI Z21.13 Category IV (pressurized vent, likely to form condensate in the vent) and requires a special vent system designed for pressurized venting.

NOTE: The venting options described here (and further detailed in the Venting section, this manual) are the lone venting options approved for this boiler. Failure to vent the boiler in accordance with the provided venting instructions will void the warranty.

 DANGER
Failure to vent the boiler properly will result in serious personal injury or death.
 WARNING
Do not attempt to vent this boiler by any means other than those described in this manual. Doing so will void the warranty and may result in severe personal injury or death.
The exhaust discharged by this boiler may be very hot. Avoid touching or other direct contact with the exhaust gases of the vent termination assembly. Doing so could result in severe personal injury or death.
Vents must be properly supported. Boiler exhaust and intake connections are not designed to carry heavy weight. Vent support brackets must be within 1' of the boiler and the balance at 4' intervals. Boiler must be readily accessible for visual inspection for first 3' from the boiler. Failure to properly support vents could result in property damage, severe personal injury, or death.

1. Direct Vent of Exhaust and Intake

If installing a direct vent option, combustion air must be drawn from the outdoors directly into the boiler intake and exhaust must terminate outdoors. There are three basic direct vent options detailed in this manual: 1. Side Wall Venting, 2. Roof Venting, and 3. Unbalanced Venting.

Be sure to locate the boiler such that the exhaust vent and intake piping can be routed through the building and properly terminated. Different vent terminals can be used to simplify and eliminate multiple penetrations in the building structure (see Optional Equipment in Venting Section). The exhaust vent and intake piping lengths, routing, and termination methods must all comply with the methods and limits given in the Venting Section, this manual.

When installing a combustion air intake from outdoors, care must be taken to utilize uncontaminated combustion air. **To prevent combustion air contamination, see Table 1.**

2. Indoor Combustion Air in Confined or Unconfined Space

This boiler requires fresh, uncontaminated air for safe operation and must be installed in a mechanical room where there is adequate combustion and ventilating air. **NOTE: To prevent combustion air contamination, see Table 1.**

Combustion air from the indoor space can be used if the space has adequate area or when air is provided through a duct or louver to supply sufficient combustion air based on the boiler input. Never obstruct the supply of combustion air to the boiler. If the boiler is installed in areas where indoor air is contaminated (see Table 1) it is imperative that the boiler be installed as direct vent so that all combustion air is taken directly from the outdoors into the boiler intake connection.

Unconfined space is space with volume greater than 50 cubic feet per 1,000 BTU/hr (4.8 cubic meters per kW) of the total input rating of all fuel-burning appliances installed in that space. Rooms connected directly to this space through openings not furnished with doors are considered part of the space. See Venting Section for details.

Confined space is space with volume less than 50 cubic feet per 1,000 BTU/hr (4.8 cubic meters per kW) of the total input rating of all fuel-burning appliances installed in that space. Rooms connected directly to this space through openings not furnished with doors are considered part of the space.

When drawing combustion air from inside a conventionally constructed building to a confined space, such space should be provided with two permanent openings: one located 6" (15 cm) below the space ceiling, the other 6" (15cm) above the space floor. Each opening should have a free area of one square inch per 1,000 BTU/hr (22cm²/kW) of the total input of all appliances in the space, but not less than 100 square inches (645cm²).

If the confined space is within a building of tight construction, air for

combustion must be obtained from the outdoors as outlined in the Venting section of this manual.

CAUTION
When drawing combustion air from the outside into the mechanical room, care must be taken to provide adequate freeze protection.
 WARNING
Failure to provide an adequate supply of fresh combustion air can cause poisonous flue gases to enter the living space, resulting in severe personal injury or death. To prevent combustion air contamination, see Table 1.

G. Carbon Monoxide Detectors

In the Commonwealth of Massachusetts and As Required by State and Local Codes:

Installation of Carbon Monoxide Detectors: At the time of installation or replacement of the vented gas fueled appliance, the installing plumber or gas fitter shall observe that a hard wired carbon monoxide detector with an alarm and battery back-up is installed on the floor level where the gas appliance is installed, unless the appliance is located in a detached, uninhabitable structure separate from the dwelling, building, or structure used in whole or in part for residential purposes.

In addition, the installing plumber or gas fitter shall observe that a hard wired carbon monoxide detector with an alarm and battery back-up is installed on each additional level of the dwelling, building, or structure served by the vented gas appliance. It shall be the responsibility of the property owner to secure the service of qualified licensed professionals for the installation of hard wired carbon monoxide detectors.

a. In the event that the vented gas fueled appliance is installed in a crawl space or attic, the hard wired carbon monoxide detector with alarm and battery back-up shall be installed on the next adjacent floor level.

b. In the event that these requirements cannot be met at the time of completion of installation, the owner shall have a period of thirty (30) days to comply with the above requirements; provided, however, that during said thirty (30) day period, a battery operated carbon monoxide detector with an alarm shall be installed.

 WARNING
Do not attempt to vent this appliance by any means other than those described in this manual. Doing so will void the warranty and may result in severe personal injury or death.

Approved Carbon Monoxide Detectors: Each carbon monoxide detector as required in accordance with the above provisions shall comply with NFPA 70 and be ANSI/UL 2034 listed and IAS certified.

H. Prevent Combustion Air Contamination

Install intake air piping for the boiler as described in the Venting Section, this manual. Do not terminate exhaust in locations that can allow contamination of intake air.

 WARNING
Ensure that the intake air will not contain any of the contaminants in Table 1. Contaminated air will damage the boiler, resulting in possible substantial property damage, severe personal injury, or death. For example, do not pipe intake air near a swimming pool or laundry facilities. These areas always contain contaminants.

Products to Avoid	Areas Likely to Have Contaminants
Spray cans containing fluorocarbons	Dry cleaning / laundry areas and establishments
Permanent wave solutions	Swimming pools
Chlorinated waxes / cleaners	Metal fabrication plants
Chlorine-based swimming pool chemicals	Beauty shops
Calcium chloride used for thawing	Refrigeration repair shops
Sodium chloride used for water softening	Photo processing plants
Refrigerant leaks	Auto body shops
Paint or varnish removers	Plastic manufacturing plants
Hydrochloric or Muriatic acid	Furniture refinishing areas and establishments
Cements and glues	New building construction
Antistatic fabric softeners used in clothes dryers	Remodeling areas
Chlorine-type bleaches, laundry detergents, and cleaning solvents	Garages and workshops
Adhesives used to fasten building products	

Table 1 - Products and Areas Likely to Have Contaminants

NOTE: DAMAGE TO THE BOILER CAUSED BY EXPOSURE TO CORROSIVE VAPORS IS NOT COVERED BY WARRANTY. (Refer to the limited warranty for complete terms and conditions.)

I. Removing a Boiler from a Common Vent System

DANGER

Do not install the boiler into a common vent with any other appliance. This will cause flue gas spillage or appliance malfunction, resulting in possible substantial property damage, severe personal injury, or death.

WARNING

Failure to follow all instructions can result in flue gas spillage and carbon monoxide emissions, causing severe personal injury or death.

When removing an existing boiler, follow the steps below.

1. Seal any unused openings in the common venting system.
2. Visually inspect the venting system for proper size and horizontal pitch to determine if there is blockage, leakage, corrosion, or other deficiencies that could cause an unsafe condition.
3. If practical, close all building doors, windows, and doors between the space in which the boiler remains connected to the common venting system and other spaces in the building. Turn on clothes dryers and any appliances not connected to the common venting system. Turn on any exhaust fans, such as range hoods and bathroom exhausts, at maximum speed. Do not operate a summer exhaust fan. Close all fireplace dampers.
4. Place in operation the appliance being inspected. Follow the lighting instructions. Adjust the thermostat so the appliance will operate continuously.
5. Test for spillage at the draft hood relief opening after 5 minutes of main burner operation. Use the flame of a match or candle or smoke from a cigarette.
6. After it has been determined that each appliance remaining connected to the common venting system properly vents when tested as outlined, return doors, windows, exhaust fans, fireplace dampers, and any other gas burning appliances to their previous

condition of use.

7. Any improper operation of the common venting system should be corrected to conform to the National Fuel Gas Code, ANSI Z223.1. When resizing any portion of the common venting system, the system should approach the minimum size as determined using the appropriate tables in Appendix G of ANSI Z223.1.

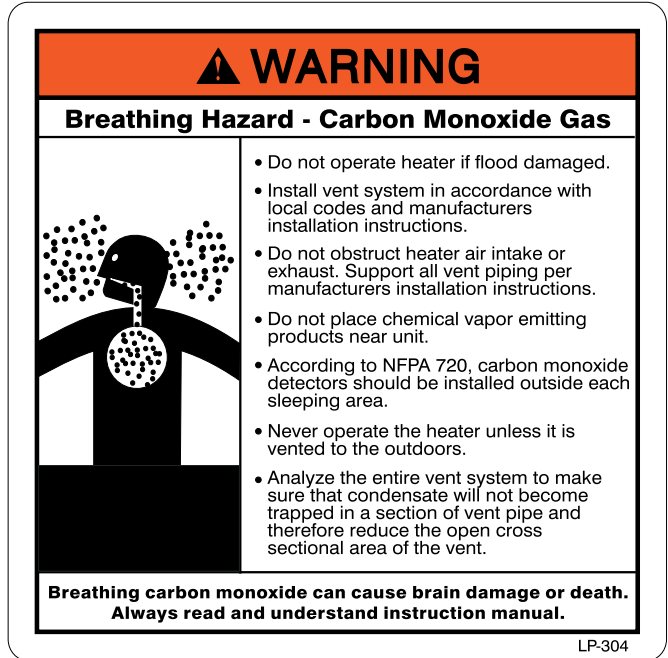

Figure 3 - CO Warning Label

J. Water Chemistry Requirements*

CAUTION

Chemical imbalance of the water supply may affect efficiency and cause severe damage to the appliance and associated equipment. It is important that the water chemistry on both the domestic hot water and central heating sides are checked before installing the appliance. Water quality must be professionally analyzed to determine whether it is necessary to treat the water. Various solutions are available to adjust water quality. Adverse water quality will affect the reliability of the system. In addition, operating temperatures above 135°F will accelerate the build-up of lime scale and possibly shorten appliance service life. Failure of an appliance due to lime scale build-up, low pH, or other chemical imbalance IS NOT covered by the warranty.

Closed loop water must be free of corrosive chemicals, sand, dirt, and other contaminants. It is up to the installer to ensure the water does not contain corrosive chemicals or elements that can damage the heat exchanger.

If you suspect that your water is contaminated in any way, discontinue use of the appliance and contact an authorized technician or licensed professional.

- **Water pH between 6.5 and 8.5**
 - pH levels below 6.5 can cause an increase in the rate of corrosion. pH of 8.5 or higher can potentially cause lime scale build-up
 - Maintain water pH between 6.5 and 8.5. Check with litmus paper or have it chemically analyzed by a local water treatment company.
 - If the pH is not between 6.5 and 8.5, consult a local water treatment company for solutions.
- **Hardness less than 7 grains (120 mg/L) (Water temperatures of 140°F and greater)**
 - Hardness levels above the required amounts can lead to lime scale build-up throughout the system. Water below 5 grains/

gallon (85 mg/L) may be over softened.

- Consult local water treatment companies for unusually hard water areas (above the required amounts) or for other treatment solutions if water is being over softened (below 5 grains/gallon [85 mg/L]).
- **Chloride concentration less than 100 ppm (mg/L)**
 - Do not fill appliance or operate with water containing chlorides in excess of 100 ppm (mg/L).
 - Using chlorinated fresh water should be acceptable as levels are typically less than 5 ppm (mg/L).
 - Do not connect the appliance to directly heat swimming pool or spa water.

- **Total Dissolved Solids (TDS) less than 500 ppm (mg/L)**

- Total dissolved solids are minerals, salts, metals, and charged particles that are dissolved in water.
- The greater the amounts of TDS present, the higher the corrosion potential due to increased conductivity in the water.
- If using softened water to fill the appliance, it is still possible to have high TDS. This water can be corrosive. Consult local water treatment companies for other treatment solutions to reduce this effect.

***NOTE:** It is recommended to clean the heat exchanger at least once a year to prevent lime scale buildup. To clean the heat exchanger, follow the maintenance procedure in this manual.

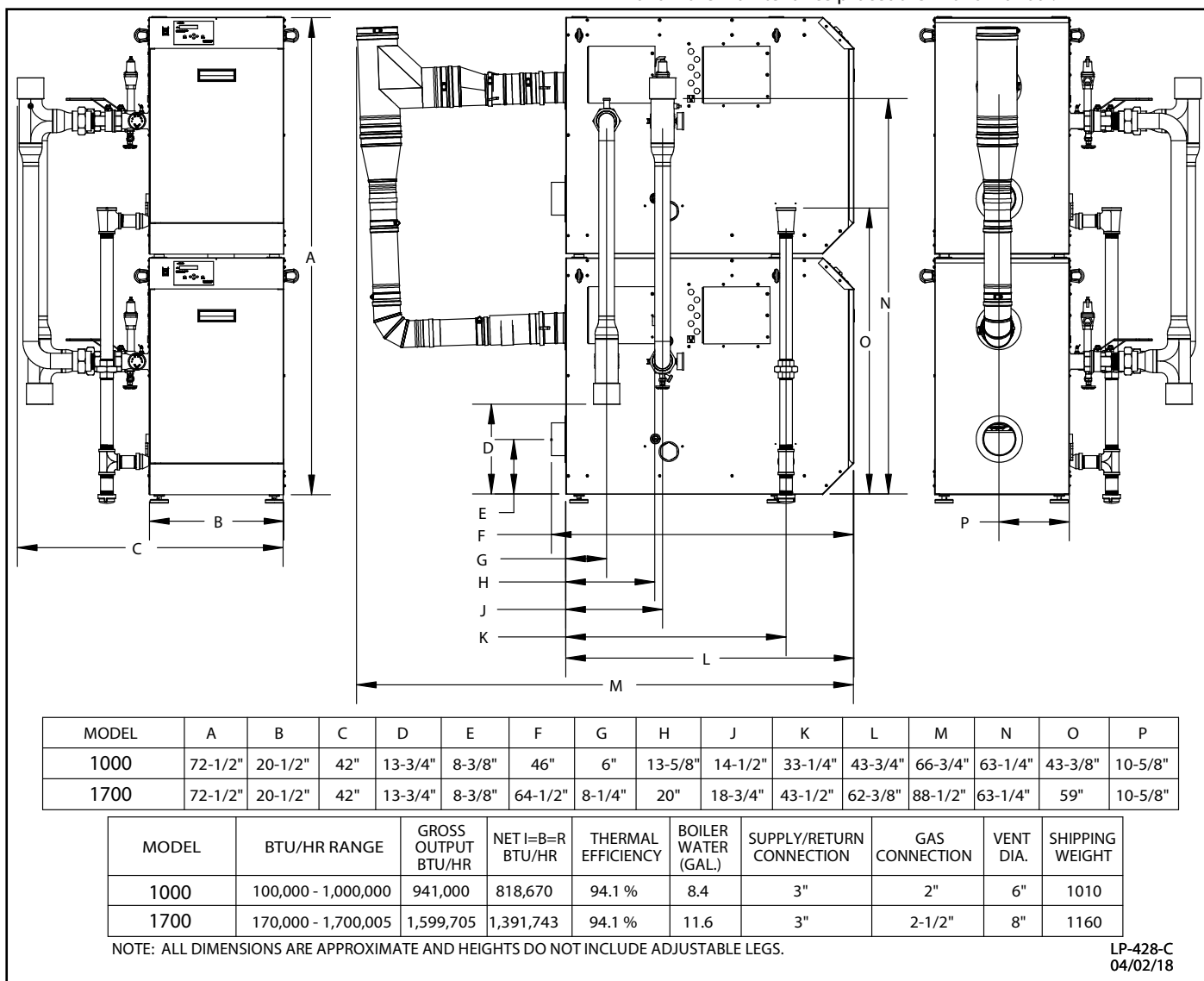



Figure 4 - Boiler Dimensions - NOTE: All Dimensions Are Approximate

K. Technical Specifications

Model		1000	1700
Installation		Indoor, Floor Standing, Fully Condensing	
Minimum / Maximum Input (Btu/Hr)		100,000 / 1,000,000	170,000 / 1,700,005
Heating Capacity (MBH)		940	1600
Flue System		Category IV, Sealed Combustion Direct Vent, Power Vent	
Minimum Combined Vent Run		16 feet	
Maximum Combined Vent Run		6" (150 feet)	8" (150 feet)
Approved Exhaust Vent Materials		PVC, CPVC, PP, Stainless Steel	
Shipping Weight (lbs)		1010	1160
Gas Supply Pressure	NG	3.5" to 14" WC	
	LP		
Manifold Pressure	Min / Max	NG/LP: -0.01" WC	
Power Supply		120V 60 Hz, 6.3A	
General Operating Conditions		Ambient Temperature Range: 33 – 104°F (0.6 – 40°C) Product Approvals and Requirements: ANSI Z21.13 / CSA 4.9	
Ignition System		Direct Electronic Spark Ignition / Flame Rectification	
Burner System		Premixed Fuel Modulation / Stainless Steel Metal Fiber Burner	
Gas Valve System		Air Ratio Valve	
Dimensions (in Inches)	W	42	
	H	72.5	
	D	66.75	88.5
Boiler Water Content (Gallons)		8.4	11.6
Minimum Flow Rate @ 30°F ΔT (GPM)		66	109
Boiler Setpoint Temperature Range		50 – 190°F / 32 - 190°F (with Outdoor Reset Curve)	
DHW Indirect Setpoint Temperature Range		70 – 185°F	
Water Pressure (PSI)	Heat Exchanger MAWP	160	
	Pressure Relief Valve	75	
Control Panel / Main Controller		LCD Display with LED Indicators / 926 SIT Control	
Connection Sizes	Supply / Return	3" NPT	
	Gas Inlet	2" NPTF	2 1/2" NPTF
Materials	Cabinet	Powder Coated Galvaneal Steel	
	Heat Exchanger	316L Stainless Steel Water Tube	
Safety Devices		Flame Rectifier Probe, Water Temperature High Limit Switch (190°F), Freeze Protection, Condensate Trap with Overflow Switch, Included LWCO (Optional UL 353 LWCO), Blocked Vent Pressure Switch, Optional Gas High/Low Pressure Switch	

Table 2 - Technical Specifications

Part 4 - Piping

 WARNING
Failure to follow the instructions in this section WILL VOID the warranty and may result in property damage, severe personal injury, or death.
CAUTION
Teflon thread sealant must be used on all connections. Failure to do so WILL VOID the warranty.

Plumbing of this product should only be done by a qualified, licensed plumber in accordance with all local plumbing codes. The boiler may be connected to an indirect water heater to supply domestic hot water. HTP offers indirect water heaters in stainless steel or glass-lined construction.

A. General Plumbing Information

CAUTION
The building piping system must meet or exceed the the piping requirements in this manual.
The control module uses temperature sensors to provide both high limit protection and modulating temperature control. The control module also provides low water protection by sensing the water level in the heat exchanger. Some codes/jurisdictions may require additional external controls.
Use two wrenches when tightening water piping at boiler. Use one wrench to prevent the boiler return or supply line from turning. Failure to prevent piping connections from turning could cause damage to boiler components.
All piping methods shown in this manual use primary / secondary connection to the boiler loop. This is to avoid the possibility of inadequate flow through the boiler. For other piping methods, consult your local HTP representative, or refer to Boiler Piping Details in this manual.

NOTE: The addition of a high temperature limiting device is important if the boiler is to be connected to a domestic hot water system.

B. Relief Valve

Connect discharge piping to a safe disposal location following the guidelines below.

 WARNING
To avoid water damage or scalding due to relief valve operation:
<ul style="list-style-type: none"> Discharge line must be connected to relief valve outlet and run to a safe place of disposal. Terminate the discharge line in a manner that will prevent possibility of severe burns or property damage should the relief valve discharge. Discharge line must be as short as possible and the same size as the valve discharge connection throughout its entire length. Discharge line must pitch downward from the valve and terminate at least 6" above the floor drain, making discharge clearly visible. The discharge line shall terminate plain, not threaded, with a material serviceable for temperatures of 375°F or greater. Do not pipe discharge to any location where freezing could occur. No valve may be installed between the relief valve and boiler or in the discharge line. Do not plug or place any obstruction in the discharge line. Test the operation of the relief valve after filling and pressurizing the system by lifting the lever. Make sure the

 WARNING
valve discharges freely. If the valve fails to operate correctly, immediately replace with a new properly rated relief valve.
<ul style="list-style-type: none"> Test T&P valve at least once annually to ensure the waterway is clear. If valve does not operate, turn the boiler "off" and call a plumber immediately. Take care whenever operating relief valve to avoid scalding injury or property damage.
FAILURE TO COMPLY WITH THE ABOVE GUIDELINES COULD RESULT IN FAILURE OF RELIEF VALVE OPERATION, RESULTING IN POSSIBILITY OF SUBSTANTIAL PROPERTY DAMAGE, SEVERE PERSONAL INJURY, OR DEATH.
Do not thread a cap or plug into the relief valve or relief valve line under any circumstances! Explosion and property damage, serious injury, or death may result.

RE-INSPECTION OF T&P RELIEF VALVES: T&P valves should be inspected AT LEAST ONCE EVERY THREE YEARS, and replaced if necessary, by a licensed plumbing contractor or qualified service technician to ensure that the product has not been affected by corrosive water conditions and to ensure that the valve and discharge line have not been altered or tampered with illegally. Certain naturally occurring conditions may corrode the valve and its components over time, rendering the valve inoperative. Such conditions can only be detected if the valve and its components are physically removed and inspected. **Do not attempt to conduct an inspection on your own.** Contact your plumbing contractor for a re-inspection to assure continued safety.

FAILURE TO RE-INSPECT THE T&P VALVE AS DIRECTED COULD RESULT IN UNSAFE TEMPERATURE AND/OR PRESSURE BUILD-UP WHICH CAN RESULT IN PROPERTY DAMAGE, SERIOUS PERSONAL INJURY, OR DEATH.

C. Backflow Preventer

Use a backflow preventer specifically designed for boiler installations. This valve should be installed on the cold water fill supply line per local codes.

D. Expansion Tank

Expansion Tank and Make-Up Water

1. Ensure that the expansion tank is sized to correctly handle boiler and system water volume and temperature.

 WARNING
Expansion tanks must be sized according to total system volume. This includes all length of pipe, all fixtures, boilers, etc. Failure to properly size for system expansion could result in wasted time, money, possible property damage, serious injury, or death.
CAUTION
Undersized expansion tanks cause system water to be lost from the relief valve, causing make-up water to be added. Eventual boiler failure can result due to excessive make-up water addition. SUCH FAILURE IS NOT COVERED BY WARRANTY.
DO NOT install automatic air vents on closed type expansion tank systems. Air must remain in the system and return to the tank to provide an air cushion. An automatic air vent would cause air to leave the system, resulting in improper operation of the expansion tank.

Expansion Tank Sizing	
Model	Heat Exchanger Volume (Gallons)
1000	8.4
1700	11.6

Table 3 - Heat Exchanger Volume

2. The expansion tank must be located as shown in Applications, this manual, or following recognized design methods. See expansion tank manufacturer's instructions for details. Always install an expansion tank designed for potable water systems.

3. Connect the expansion tank to the air separator only if the separator is on the suction side of the circulator. Always install the system fill connection at the same point as the expansion tank connection to the system.

4. Most chilled water systems are piped using a closed type expansion tank.

Diaphragm (or Bladder) Expansion Tank

Always install an automatic air vent on top of the air separator to remove residual air from the system.

E. Circulators

CAUTION
DO NOT use the boiler circulator in any location other than the ones shown in this manual. The boiler circulator location is selected to ensure adequate flow through the boiler. Failure to comply with this caution could result in unreliable performance and nuisance shutdowns from insufficient flow.

Sizing Space Heat System Piping

1. In all diagrams, the space heating system is isolated from the boiler loop by the primary / secondary connection.
2. Size the piping and components in the space heating system using recognized design methods.

F. Hydronic Piping with Circulators, Zone Valves, and Multiple Boilers

The boiler is designed to function in a closed loop hydronic system. The included temperature and pressure gauge allows the user to monitor system pressure and outlet temperature from the boiler. It is important to note that the boiler has a minimal amount of pressure drop that must be calculated when sizing the circulators. Each boiler installation must have an air elimination device that will remove air from the system.

Install the boiler so the gas ignition system components are protected from water (dripping, spraying, etc.). Allow clearance for basic service of the boiler circulator, valves, and other components. Observe minimum 1" clearance around all uninsulated hot water pipes when openings around pipes are not protected by non-combustible materials.

On a boiler installed above radiation level, some states and local codes require a low water cut off device. This is provided standard on the boiler. Check with local codes for additional requirements. If the boiler supplies hot water to heating coils in air handler units, flow control valves or other devices must be installed to prevent gravity circulation of boiler water in the coils during the cooling cycle. Chilled water medium must be piped in parallel with the boiler.

Freeze protection for new or existing systems must use glycol specifically formulated for this purpose. This glycol must include inhibitors that will prevent it from attacking metallic system components. Make certain that the system fluid is checked for the correct glycol concentration and inhibitor level. The system should be tested at least once a year and as recommended by the producer of the glycol solution. Allowance should be made for the expansion of the glycol solution in the system piping. Example: 50% by volume glycol solution expands 4.8% in volume for the temperature increase from 32°F to 180°F, while water expands 3% over the same temperature rise.

CAUTION
The boiler should not be operated as a potable hot water heater. The boiler should not be used as a direct hot water heating device.

G. Circulator Sizing

In addition, the boiler heat exchanger has a minimum total water volume that must be taken into account when sizing the circulator. Minimum boiler flow rates are listed in the table below.

Minimum Boiler Flow Rates	
Model	Minimum Flow (GPM)
1000	66
1700	109

Table 4 - Minimum Flow Rates

The boiler heat exchanger does have a pressure drop which must be considered in system design. Refer to the graph in Table 5 for pressure drop through the boiler heat exchanger.

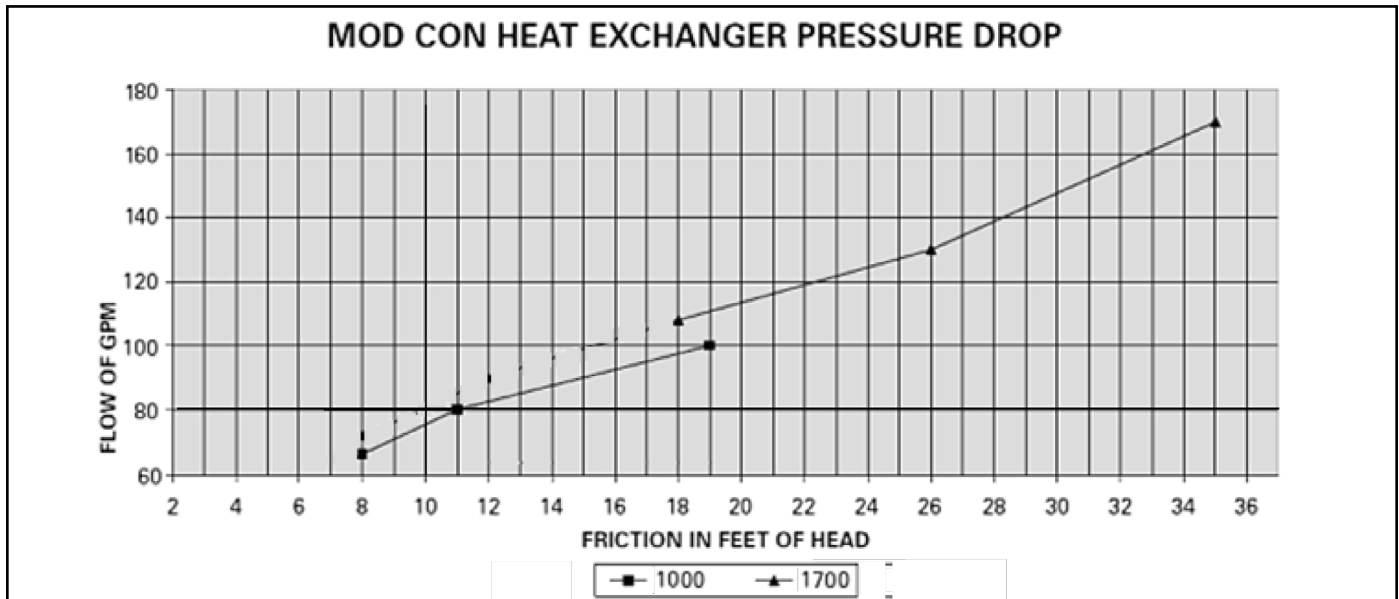

Table 5 - Heat Exchanger Pressure Drop

The chart below represents various system design temperature rise through the boiler along with respective flows and friction loss. This is provided to aid in circulator selection.

System Temperature Rise Chart						
Model	20°Δt		25°Δt		30°Δt	
	Friction Ft	Flow Rate (GPM)	Friction Ft	Flow Rate (GPM)	Friction Ft	Flow Rate (GPM)
1000	19'	100	11'	80	8'	66
1700	35'	170	26'	130	18'	109

Table 7 - Temperature Rise, Friction Feet, and Flow Rate

The chart below represents the combined flow rates and pipe sizes when using multiple boilers to design the manifold system for the primary circuit. To size, simply add the number of boilers and the required flow rates for the system design temperature.

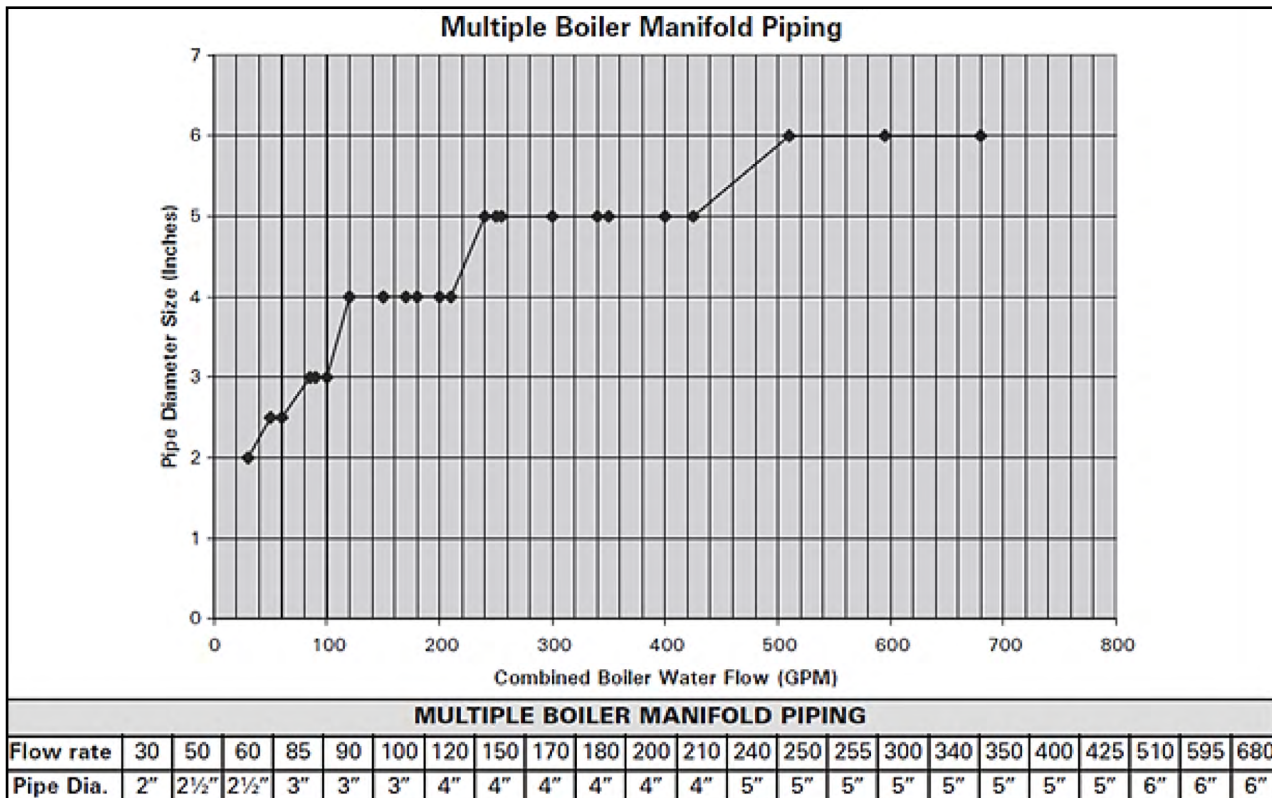

Table 6 - Multiple Boiler Manifold Piping

H. Check / Control Water Chemistry

CAUTION

Chemical imbalance of the water supply may affect efficiency and cause severe damage to the appliance and associated equipment. It is important that the water chemistry on both the domestic hot water and central heating sides are checked before installing the appliance. Water quality must be professionally analyzed to determine whether it is necessary to treat the water. Various solutions are available to adjust water quality. Adverse water quality will affect the reliability of the system. In addition, operating temperatures above 135°F will accelerate the build-up of lime scale and possibly shorten appliance service life. Failure of an appliance due to lime scale build-up, low pH, or other chemical imbalance IS NOT covered by the warranty.

Closed loop water must be free of corrosive chemicals, sand, dirt, and other contaminants. It is up to the installer to ensure the water does not contain corrosive chemicals or elements that can damage the heat exchanger.

If you suspect that your water is contaminated in any way, discontinue use of the appliance and contact an authorized technician or licensed professional.

- **Water pH between 6.5 and 8.5**
- **Hardness less than 7 grains (120 mg/L) (Water temperatures of 140°F and greater)**
- **Chloride concentration less than 100 ppm (mg/L)**
- **Total Dissolved Solids (TDS) less than 500 ppm (mg/L)**

***NOTE:** It is recommended to clean the heat exchanger at least once a year to prevent lime scale buildup. To clean the heat exchanger, follow the maintenance procedure in this manual.

Clean system to remove sediment*

1. You must thoroughly flush the system (without boiler connected) to remove sediment. The high-efficiency heat exchanger can be damaged by buildup or corrosion due to sediment.
2. For zoned systems, flush each zone separately through a purge valve. (If purge valves and isolation valves are not already installed, install them to properly clean the system.)
3. Flush system until water runs clean and you are sure piping is free of sediment.

***NOTE:** It is recommended you clean heat exchanger at least once a year to prevent lime scale buildup. Follow the maintenance procedure to clean the heat exchanger in the Maintenance Section of this manual.

Test/replace freeze protection fluid

1. For systems using freeze protection fluids, follow fluid manufacturer's instructions to verify inhibitor level and that other fluid characteristics are satisfactory.
2. Freeze protection fluid must be replaced periodically due to degradation of inhibitors over time. Follow all fluid manufacturer instructions.

Piping Components

Heating System Piping

System piping MUST be sized per technical pipe requirements listed in Tables 6 and 7. Reducing pipe size can restrict flow rate through the boiler, causing inadvertent short cycling and poor system performance.

Check Valves

Field supplied. Check valves are recommended for installation as shown in Applications.

Isolation Valves

Field supplied. Full port ball valves are required. Failure to use full port ball valves could result in a restricted flow rate through the boiler.

Anti-Scald Mixing Valve

Field supplied. An anti-scald mixing valve is recommended when storing domestic hot water above 115°F.

Unions

Field supplied. Recommended for unit serviceability.

Pressure Relief Valve

Factory supplied on boiler. The pressure relief valve is sized to ASME specifications. Storage tank may require additional relief valves depending on local codes.

I. Plumbing

CAUTION

This boiler should not be operated as a potable hot water heater. It should not be used as a direct hot water heating device.

Basic steps are listed below that will guide the installation of the boiler.

1. Connect the system return marked "Boiler Return".
2. Connect the system supply marked "Boiler Supply".
3. Install purge and balance valve or shut off valve and drain on system return to purge air out of each zone.
4. Install a back flow preventer on the cold feed make-up water line.
5. Install a pressure reducing valve on the cold feed make-up water line (15 PSI nominal on the system return). Check temperature and pressure gauge when operating. It should read a minimum pressure of 12 PSI.
6. Install a circulator as shown in piping details (this section). Make sure the circulator is properly sized for the system and friction loss.
7. Install an expansion tank on the system supply. Consult the tank manufacturer's instructions for specific information relating to expansion tank installation. Size the expansion tank for the required system volume and capacity.
8. Install an air elimination device on the system supply.
9. Install a drain valve at the lowest point of the system. **NOTE:** The boiler cannot be drained completely of water without purging the unit with an air pressure of 15 PSI.
10. The relief valve is installed at the factory. A pipe discharge line should be installed to discharge 6" above the drain in the event of pressure relief. The pipe size must be the same size as the relief valve outlet. **NEVER BLOCK THE OUTLET OF THE SAFETY RELIEF VALVE.**

J. Fill and Purge Heating System

- Attach the hose to balance and purge hose connector or drain valve and run hose to nearest drain.
- Close the other side of the balance and purge valve or the shut off valve after the drain.
- Open first zone balance and purge or drain valve to let water flow out the hose. If zone valves are used, open the valves one at a time manually. (NOTE: You should check the valve manufacturer's instructions prior to opening valves manually, so as not to damage the valves.)
- Manually operate fill valve regulator. When water runs out of the hose, you will see a steady stream of water (without bubbles). Close balance and purge valve or drain to stop the water from flowing. Disconnect the hose and connect it to next zone to be purged.
- Repeat this procedure for additional zones (one at a time).

CAUTION

For installation that incorporates standing iron radiation and systems with manual vents at the high points, follow previous section and, starting with the nearest manual air vent, open until water flows out. Then close vent. Repeat procedure, working your way toward the furthest air vent. It may be necessary to install a basket strainer in an older system where larger amounts of sediment may be present. Annual cleaning of the strainer may be necessary.

Upon completion, make sure that the fill valve is in the automatic position and each zone balance and purge or shut off is in an open position and zone valves are positioned for automatic operation.

K. Freeze Protection Fluids

CAUTION

Use only inhibited glycol solutions which are specially formulated for hydronic systems. Ethylene glycol is toxic and can attack gaskets and seals used in hydronic systems. Glycol mixtures should not exceed 50%.

1. Glycol in hydronic applications is specially formulated for this purpose, and includes inhibitors that prevent the glycol from attacking metallic system components. Make certain that the system fluid is checked for the correct glycol concentration and inhibitor level.
2. The glycol solution should be tested at least once a year and as recommended by the glycol manufacturer.
3. Anti-freeze solutions expand more than water. For example: A 50% by volume solution expands 4.8% in volume for a temperature increase from 32oF to 180oF, while water increases 3% over the same temperature rise. Allowances must be made for this expansion in the system design.
4. A 30% mixture of glycol will result in a BTU output loss of 15% with a 5% increase in head against the system circulator.
5. A 50% mixture of glycol will result in a BTU output loss of 30% with a 50% increase in head against the system circulator.

CAUTION

It is highly recommended that you carefully follow the glycol manufacturer's recommended concentrations, expansion requirements, and maintenance recommendations (pH additive breakdown, inhibitor reduction, etc.). Carefully figure the additional friction loss in the system as well as the reduction in heat transfer coefficients.

L. Zoning with Zone Valves

1. When zoning with zone valves, connect the boiler to the system as shown in Applications. The primary/secondary piping shown ensures the boiler loop will have sufficient flow. It also avoids applying the high head of the boiler circulator to the zone valves.
2. Connect DHW (domestic hot water) piping to indirect storage water heater as shown in Applications.

M. Zoning with Circulators

1. When using circulator zoning, connect the boiler to the system as shown in Applications. NOTE: The boiler circulator cannot be used for a zone. It must only supply the boiler loop.
2. Install a separate circulator for each zone.
3. Connect DHW (domestic hot water) piping to indirect storage water heater as shown in Applications.

N. Multiple Boilers

1. Connect multiple boilers as shown in Applications.
2. All piping shown is reverse return to assure balanced flow throughout the connected boilers.
3. Each connected boiler must have its own circulator pump to assure adequate flow.
4. Connect DHW (domestic hot water) piping to indirect storage water heater as shown in Applications.
5. The system flow (secondary loop) must be greater than the boiler's primary loop flow.

CAUTION

Water temperature above 140°F requires the circulator pump to run continuously and water hardness between 5 and 7 grains. Hardness above 7 grains will damage the heat exchanger and shorten the service life of the boiler.

O. Applications

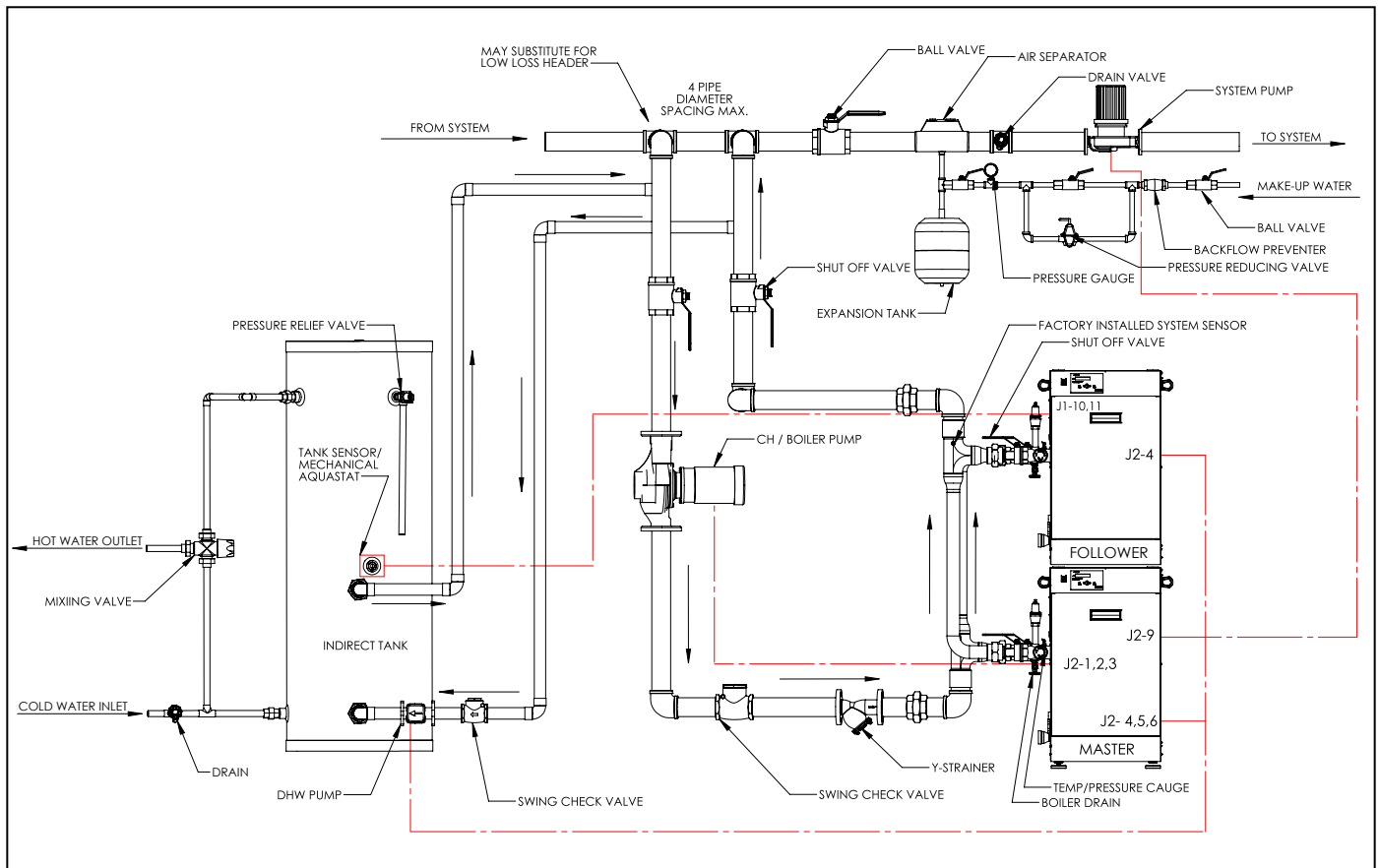

Figure 5 - Space Heating - Indirect Priority

FIGURE NOTES:

1. This drawing is meant to demonstrate system piping concept only.
2. A mixing valve is recommended if the DHW temperature is set above the factory setting of 119°F.
3. Install a minimum of 12 diameters of straight pipe upstream of all circulators.
4. Install a minimum of 6 diameters of straight pipe up and downstream of all closely spaced tees.
5. Piping shown is Primary/Secondary.
6. The minimum pipe size for connecting an HTP indirect fired water heater is 1".
7. The minimum pipe size for connecting a Mod Con boiler is 3" for both the 1000 and 1700 models.
8. System flow (Secondary Loop) must be greater than the boiler's Primary Loop flow.
9. Installations must comply with all local codes.
10. In Massachusetts, a vacuum relief valve must be installed on the cold water line per 248 CMR.
11. If boiler supply temperature for DHW is set higher than central heating and system pump is not powered by the master boiler, the central heating circuit must be protected by a thermostatic mixing valve.

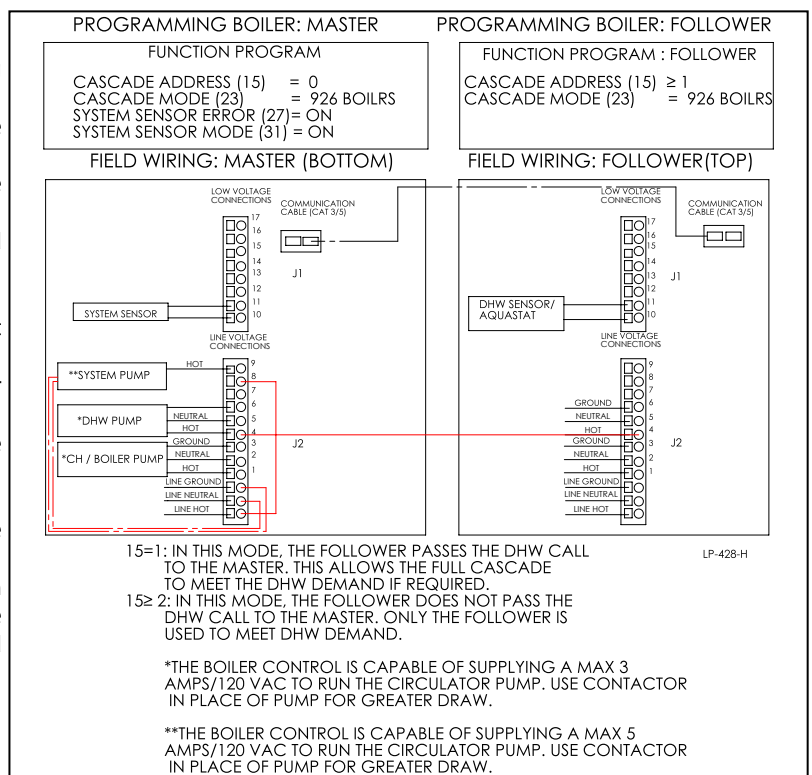

Figure 6 - Space Heating - Indirect Priority Wiring

WARNING

An ASSE 1017 thermostatic mixing valve is recommended on all tanks if the hot water temperature leaving the tank is above 119°F. Failure to do so could result in substantial property damage, serious injury, or death.

The piping will not support the weight of the circulators. Refer to the circulator manufacturer's instructions to properly support the circulator. Failure to comply with these instructions could result in property damage, severe personal injury, or death.

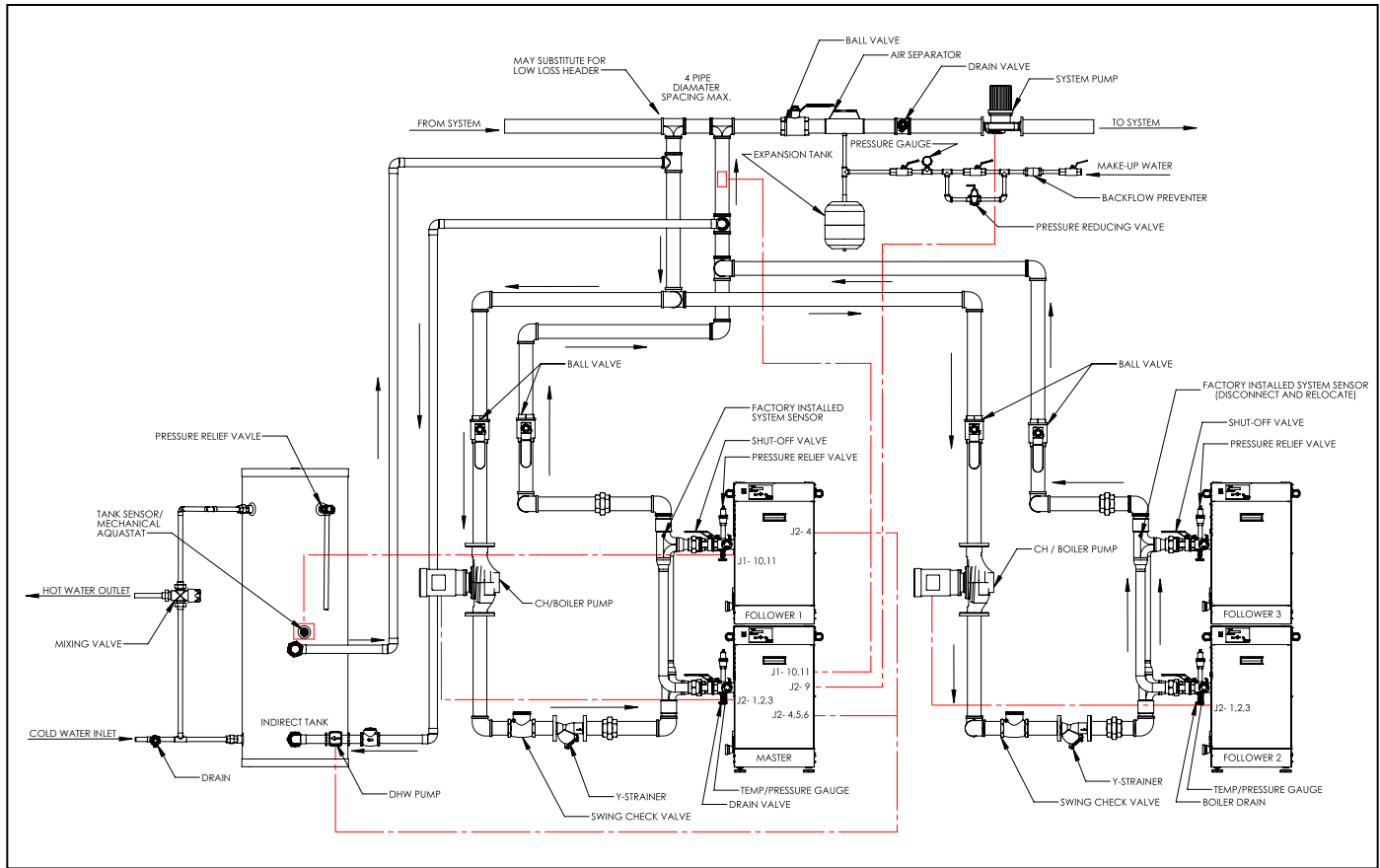

Figure 7 - Space Heating - Indirect Priority

FIGURE NOTES:

1. This drawing is meant to demonstrate system piping concept only.
2. A mixing valve is recommended if the DHW temperature is set above the factory setting of 119°F.
3. Install a minimum of 12 diameters of straight pipe upstream of all circulators.
4. Install a minimum of 6 diameters of straight pipe up and downstream of all closely spaced tees.
5. Piping shown is Primary/Secondary.
6. The minimum pipe size for connecting an HTP indirect fired water heater is 1".
7. The minimum pipe size for connecting a Mod Con boiler is 3" for both the 1000 and 1700 models. See Multiple Boiler Manifold Piping chart, this manual, when sizing and installing a multiple boiler system.
8. System flow (Secondary Loop) must be greater than the boiler's Primary Loop flow.
9. Installations must comply with all local codes.
10. In Massachusetts, a vacuum relief valve must be installed on the cold water line per 248 CMR.
11. System sensor must be placed as shown in the drawing.
12. If boiler supply temperature for DHW is set higher than central heating and system pump is not powered by the master boiler, the central heating circuit must be protected by a thermostatic mixing valve.

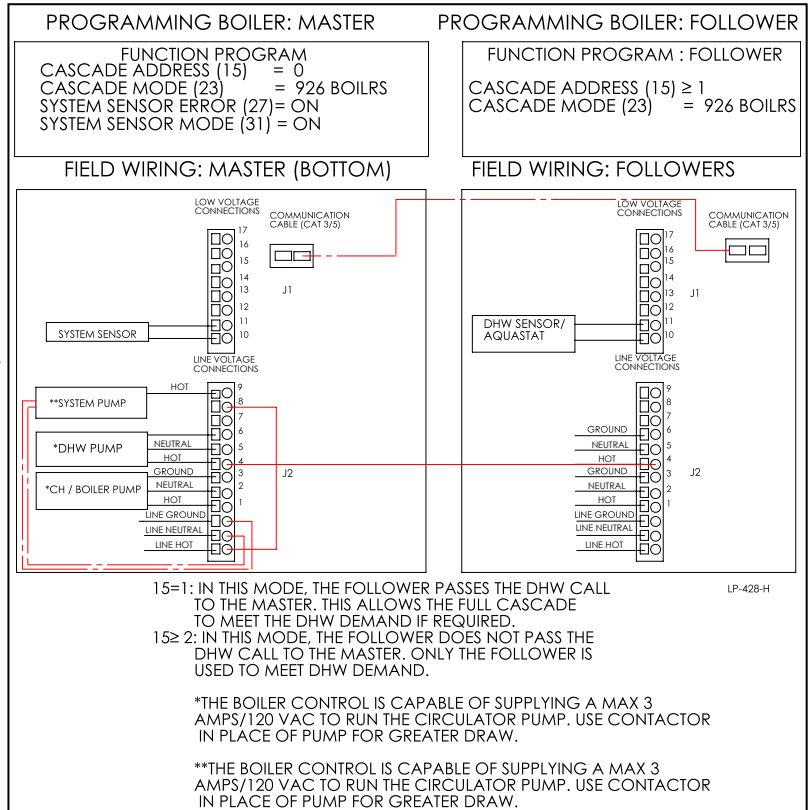

Figure 8 - Space Heating - Indirect Priority Wiring

WARNING

An ASSE 1017 thermostatic mixing valve is recommended on all tanks if the hot water temperature leaving the tank is above 119°F. Failure to do so could result in substantial property damage, serious injury, or death.

The piping will not support the weight of the circulators. Refer to the circulator manufacturer's instructions to properly support the circulator. Failure to comply with these instructions could result in property damage, severe personal injury, or death.

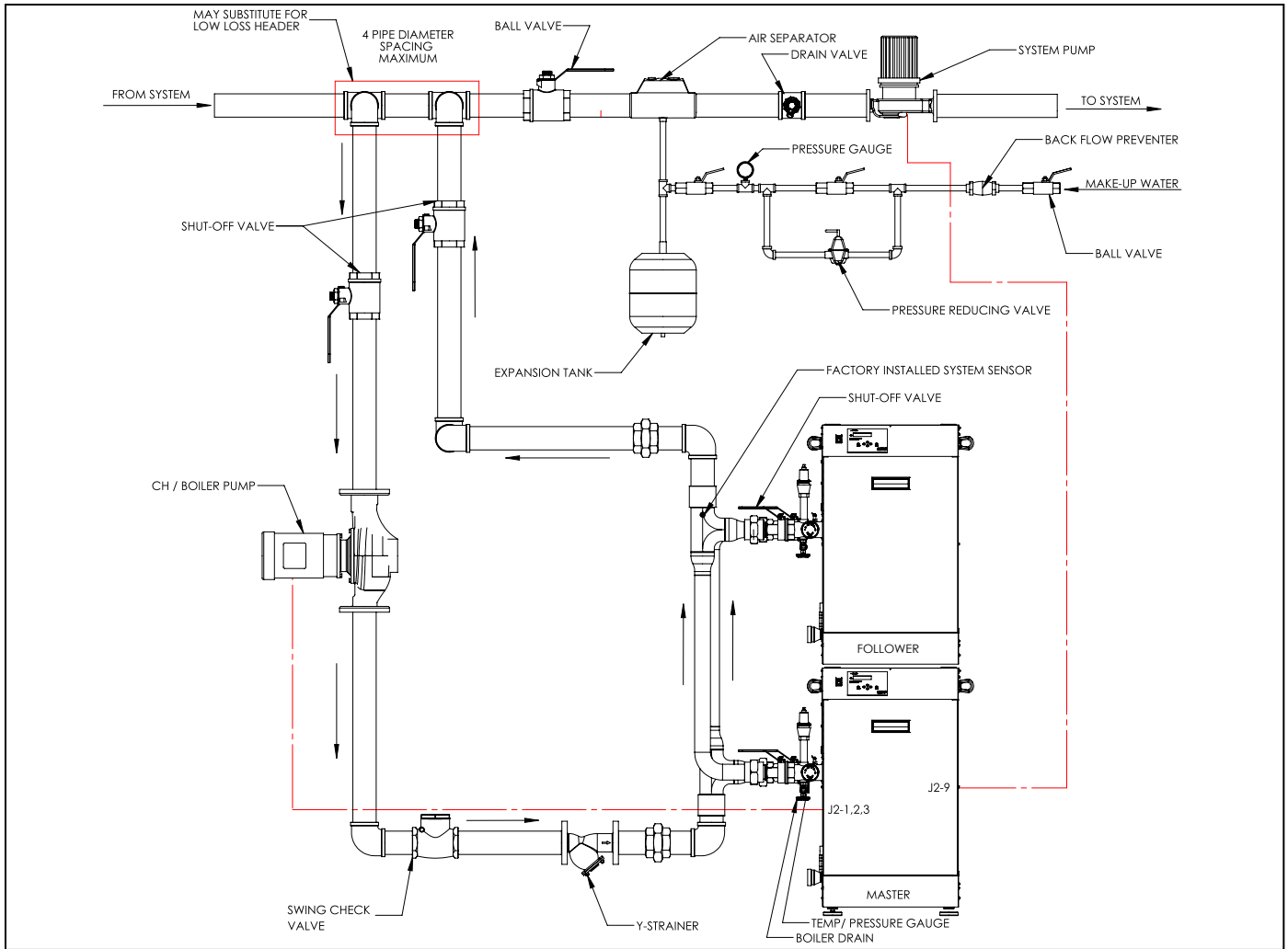

Figure 9 - Cascaded Space Heating

FIGURE NOTES:

1. This drawing is meant to demonstrate system piping concept only.
2. Install a minimum of 12 diameters of straight pipe upstream of all circulators.
3. Install a minimum of 6 diameters of straight pipe up and downstream of all closely spaced tees.
4. Piping shown is Primary/Secondary.
5. The minimum pipe size for connecting a Mod Con boiler is 3" for both the 1000 and 1700 models.
6. System flow (Secondary Loop) must be greater than the boiler's Primary Loop flow.
7. Installations must comply with all local codes.

WARNING

The piping will not support the weight of the circulators. Refer to the circulator manufacturer's instructions to properly support the circulator. Failure to comply with these instructions could result in property damage, severe personal injury, or death.

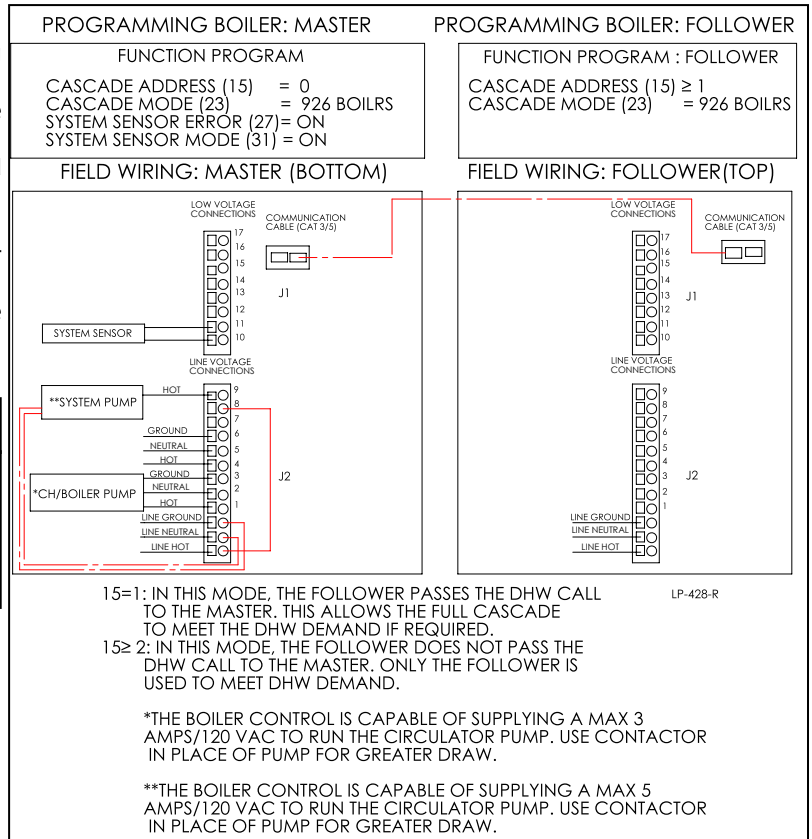

Figure 10 - Cascaded Space Heating Wiring

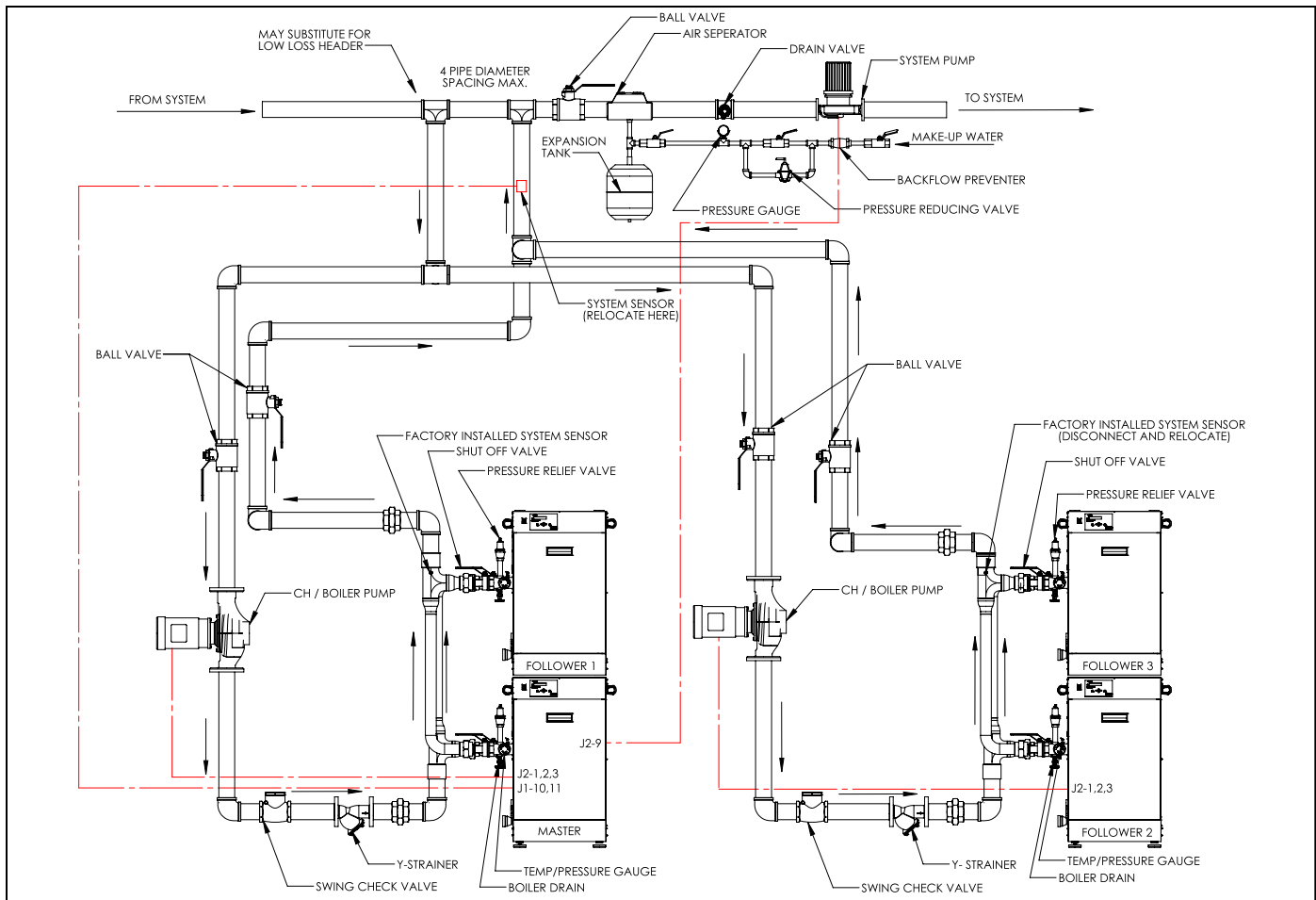

Figure 11 - Cascaded Space Heating

FIGURE NOTES:

1. This drawing is meant to demonstrate system piping concept only.
2. Install a minimum of 12 diameters of straight pipe upstream of all circulators.
3. Install a minimum of 6 diameters of straight pipe up and downstream of all closely spaced tees.
4. Piping shown is Primary/Secondary.
5. The minimum pipe size for connecting a Mod Con boiler is 3" for both the 1000 and 1700 models. See Multiple Boiler Manifold Piping chart, this manual, when sizing and installing a multiple boiler system.
6. System flow (Secondary Loop) must be greater than the boiler's Primary Loop flow.
7. Installations must comply with all local codes.
8. System sensor must be placed as shown in the drawing.

WARNING

The piping will not support the weight of the circulators. Refer to the circulator manufacturer's instructions to properly support the circulator. Failure to comply with these instructions could result in property damage, severe personal injury, or death.

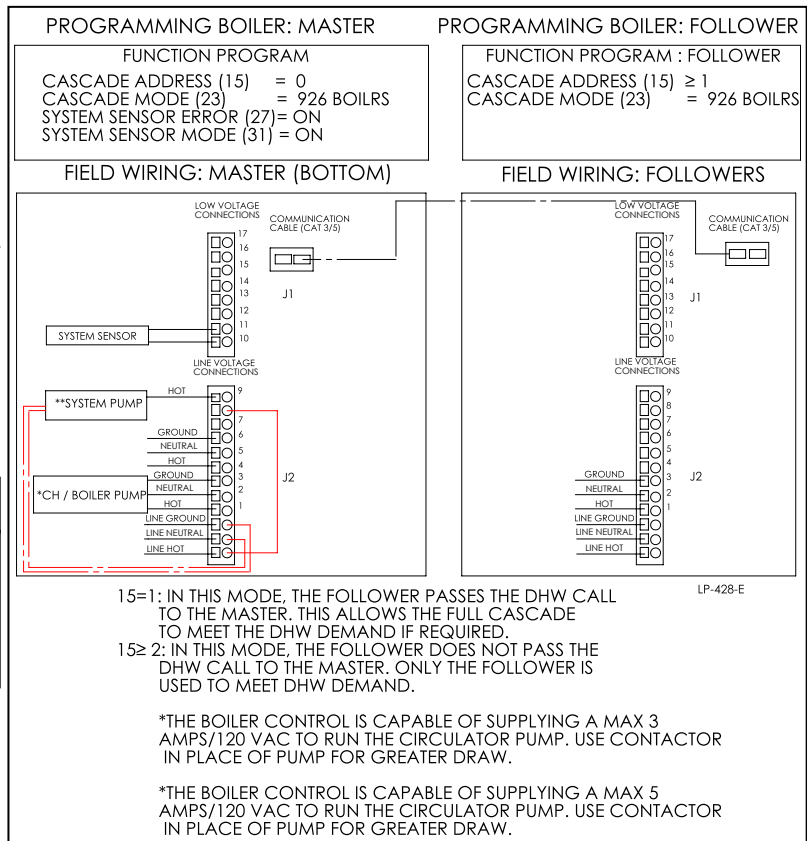

Figure 12 - Cascaded Space Heating Wiring

Part 5 - Venting

⚠ DANGER

The boiler must be vented as detailed in this section. Ensure exhaust vent and intake piping complies with these instructions regarding vent system. Inspect finished exhaust vent and intake piping thoroughly to ensure all joints are well secured, airtight, and comply with all applicable code requirements, as well as the instructions provided in this manual. Failure to properly install the vent system will result in severe personal injury or death.

A. General

⚠ DANGER

This boiler is certified as a "Category IV" appliance and requires a special venting system. The vent system will operate with a positive pressure in the pipe. Exhaust gases must be piped directly outdoors using the vent materials and rules outlined in these instructions. Do not connect vent connectors serving appliances vented by natural draft into any portion of mechanical draft systems operating under positive pressure. Follow the venting instructions carefully. Failure to do so will result in substantial property damage, severe personal injury, or death.

1. Installation should be made in accordance with the regulations of the Authority Having Jurisdiction, local code authorities, and utility companies which pertain to this type of water heating equipment.
2. Install the venting system in accordance with these instructions and with the National Fuel Gas Code, ANSI Z223.1/NFPA 54, CAN/CGA B149, and / or applicable provisions of local building codes.
3. This boiler must be vented with materials, components, and systems listed and approved for Category IV appliances.

⚠ DANGER

Exhaust and intake are to be piped separately. This boiler cannot share a common exhaust or intake with multiple appliances. Failure to follow these instructions will result in substantial property damage, severe personal injury, or death.

NOTE: To avoid contamination often contained in indoor air, it is best to pipe all intake combustion air directly to the outdoors.

NOTE: Care must be taken to prevent condensate freezing in the exhaust vent pipe system. See local, state, provincial, and national codes for best practices to prevent condensate freezing in the exhaust vent pipe system.

⚠ WARNING

Improper seating of vent pipe gaskets can cause eventual gasket failure and exhaust gas leakage. Ensure the exhaust vent pipe is properly beveled and seated before insertion into the flue adapter. Failure to do so could result in property damage, severe personal injury, or death.

Exhaust vent adaptors are not designed as load-bearing devices, and must not be used to support exhaust vent piping. All vent pipes must be properly connected, supported, and the exhaust vent must be pitched a minimum of 1/4" per foot back to the boiler to allow drainage of condensate. Failure to properly support vent piping and follow the information in this statement could result in product damage, severe personal injury, or death.

⚠ WARNING

Breathing Hazard - Carbon Monoxide Gas

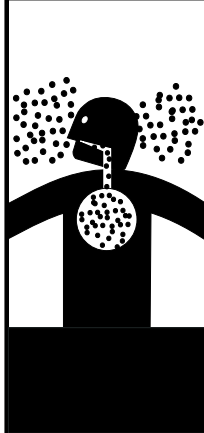

- Do not operate heater if flood damaged.
- Install vent system in accordance with local codes and manufacturers installation instructions.
- Do not obstruct heater air intake or exhaust. Support all vent piping per manufacturers installation instructions.
- Do not place chemical vapor emitting products near unit.
- According to NFPA 720, carbon monoxide detectors should be installed outside each sleeping area.
- Never operate the heater unless it is vented to the outdoors.
- Analyze the entire vent system to make sure that condensate will not become trapped in a section of vent pipe and therefore reduce the open cross sectional area of the vent.

Breathing carbon monoxide can cause brain damage or death. Always read and understand instruction manual.

LP-304

⚠ DANGER

Due to the extreme flammability of most glues, cements, solvents, and primers used to join plastic exhaust vent and intake pipes, explosive solvent vapors must be cleared from all vent piping before start-up. Avoid using excess cement or primer, as this may pool in the vent pipes. Vent assemblies should be allowed to cure for a period of at least 8 hours before powering a connected appliance. Failure to follow these instructions will result in substantial property damage, severe personal injury, or death. It is the installers' responsibility to understand the hazards associated with explosive solvents and take the necessary precautions to avoid these risks.

⚠ WARNING

- DO NOT insulate the first three (3) linear feet of the exhaust vent run.
- CPVC, Polypropylene, or Stainless Steel pipe material MUST be used if the first three (3) linear feet of the exhaust vent run is insulated or passes through an enclosed space greater than 6" in length, such as a wall.
- If CPVC is used to meet these requirements, the balance may be installed with approved PVC pipe.
- If Polypropylene or Stainless Steel is used to meet these requirements, the balance of the vent run must be installed with the same material.
- Failure to comply with this warning could result in property damage, severe personal injury, or death.

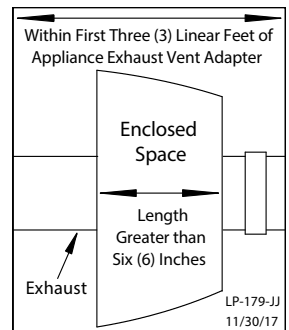

B. Approved Materials for Exhaust Vent and Intake Pipe

Item	Material	Standards for Installation In:	
		United States	Canada
Pipe and Fittings Approved for Intake ONLY	ABS*	ANSI/ASTM D2661	NOT PERMITTED
Pipe Approved for Intake OR Exhaust Vent	PVC Schedule 40/80	ANSI/ASTM D1785	PVC, CPVC, and PP Venting Must be ULC-S636 Certified. IPEX is an approved manufacturer in Canada.
	PVC-DWV Schedule 40/80	ANSI/ASTM D2665	
	CPVC Schedule 40/80	ANSI/ASTM F441	
	Polypropylene	UL-1738 or ULC-S636	
	Stainless Steel AL29-4C	Certified for Category IV and Direct Vent Appliance Venting	
Pipe Fittings	PVC Schedule 40	ANSI/ASTM D2466 or D2665	PVC, CPVC, and PP Venting Must be ULC-S636 Certified. IPEX is an approved manufacturer in Canada.
	PVC Schedule 80	ANSI/ASTM D2467 or D2665	
	CPVC Schedule 40	ANSI/ASTM F438	
	CPVC Schedule 80	ANSI/ASTM F439	
Pipe Cement	ABS*	ANSI/ASTM D2235	NOT PERMITTED
	PVC	ANSI/ASTM D2564	IPEX System 636 Cements and Primers
	CPVC	ANSI/ASTM F493	
Pipe Primer	PVC / CPVC	ASTM F656	

! DANGER

- The exhaust and intake components installed with this boiler must be used for near boiler piping BEFORE transitioning to the approved materials listed above. DO NOT REMOVE these installed components. Doing so WILL VOID boiler warranty.
 - PVC / CPVC pipe and fittings of the same diameter are considered interchangeable.
 - DO NOT use Foam Core Pipe in any portion of the exhaust piping from this boiler.
 - DO NOT connect PVC/CPVC to Polypropylene without an approved vent connector.
 - Any transition to Polypropylene MUST be done in the vertical within five (5) feet of the appliance.
 - When installing AL29-4C vent piping, install a PVC-to-stainless adapter at the boiler vent connection, and at the termination when using a PVC termination kit. DO NOT mix AL29-4C piping from different manufacturers unless using adapters specifically designed for the purpose by the manufacturer.
 - A double wall vent may be used when using stainless steel vent material in a freezing climate.
 - *ABS may be used for air intake applications ONLY. ABS is NOT PERMITTED for use in Canada.
 - Contact the venting material manufacturer if there is any question about the applicability of the proposed venting material.
- Failure to follow these directions will result in substantial property damage, severe personal injury, or death.

Table 8 - Approved Materials for Exhaust Vent and Intake Pipe

! WARNING
DO NOT mix components from different venting systems without proper adapters. The vent system could fail, causing leakage of flue products into the living space. Use only the approved pipe and fitting materials, and primer and cement specifically designed for the material used, as listed in the above table. Failure to do so could result in property damage, serious injury, or death.
CAUTION
High heat sources (generating heat 100°F / 37°C or greater, such as boiler flue pipes, space heaters, etc.) may damage plastic components of the boiler as well as plastic vent pipe materials. Such damages ARE NOT covered by warranty. It is recommended to keep a minimum clearance of 8" from high heat sources. Observe heat source manufacturer instructions, as well as local, state, provincial, and national codes, laws, regulations, and ordinances when installing this boiler and related components near high heat sources.

NOTE: The use of double-wall vent or insulated material for the combustion air intake pipe is recommended in cold climates to prevent the condensation of airborne moisture in the incoming combustion air.

! DANGER
You must not use "B" vent in an exhaust application. "B" vent is for intake applications ONLY. Using "B" vent in an exhaust application will result in serious injury or death.
! WARNING
It is required to insert exhaust and intake screens into the vent terminations to prevent blockage caused by debris or birds. Failure to keep terminations clear could result in property damage, severe personal injury, or death.

C. Additional Requirements for Installation in Canada

1. Installations must be made with a vent pipe system certified to ULC-S636. IPEX is an approved vent manufacturer in Canada supplying vent material listed to ULC-S636. Additionally, you may use AL29-4C stainless steel venting to comply with Canadian requirements.
 2. The first three (3) feet of vent pipe from the boiler flue outlet must be readily accessible for visual inspection.
 3. The components of the certified vent system must not be interchanged with other vent systems or unlisted pipe / fittings.
- Cellular foam core piping may be used on air inlet piping **only**.

D. Exhaust Vent and Intake Pipe Location

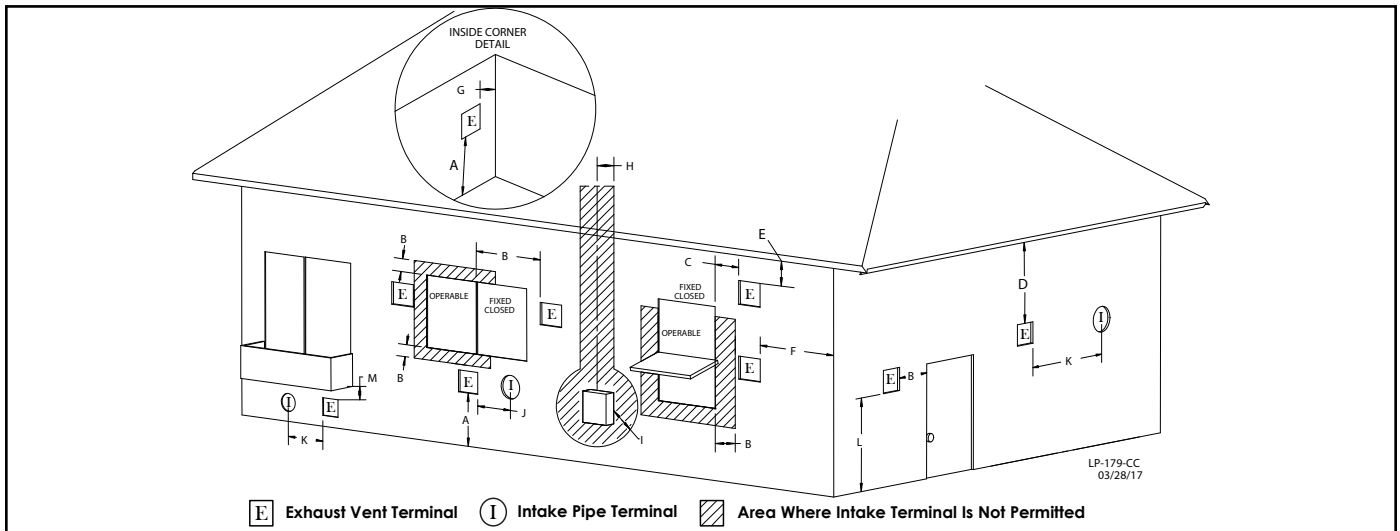

Figure 13 - Exit Terminals for Direct Vent Systems - ANSI Z223.1 / NFPA 54 for US and CAN/CSA B149.1 for Canada

DESCRIPTION		US	CANADA
A	Clearance above grade, veranda, porch, deck, or balcony	1 foot (30 cm)	
B	Clearance to window or door that may be opened	Direct Vent	1 foot
		Power Vent	4 ft below or to side of opening; 1 ft above opening
C	Clearance to permanently closed window	*	
D	Vertical clearance to ventilated soffit located above the terminal within a horizontal distance 2 feet (61 cm) from the center line of the terminal	*	
E	Clearance to unventilated soffit	*	
F	Clearance to outside corner	*	
G	Clearance to inside corner	*	
H	Clearance to each side of center line extended above meter / regulator assembly	*	
I	Clearance to service regulator vent outlet	*	Above a regulator within 3 feet (91 cm) horizontally of the vertical center line of the regulator vent outlet to a maximum vertical distance of 15 ft (4.5 m)
J	Clearance to nonmechanical air supply inlet to building or the combustion air inlet to any other appliance	Direct Vent	1 foot
		Power Vent	4 ft below or to side of opening; 1 ft above opening
K	Clearance to mechanical air supply inlet	3 feet above if within 10 feet horizontally	6 feet (1.83 m)
L	Clearance above paved sidewalk or paved driveway located on public property	Direct Vent	*
		Power Vent	7 feet (2.13 m)
M	Clearance under veranda, porch deck, or balcony	*	

Table 9 - Vent Termination Clearances - *NOTE: For clearances not specified in ANSI Z223.1 / NFPA 54 for US and CAN/CSA B149.1 for Canada, please use clearances in accordance with local installation codes and the requirements of the gas supplier.

WARNING

The building owner is responsible for keeping the exhaust and intake terminations free of snow, ice, or other potential blockages, as well as scheduling routing maintenance. Failure to keep the vent piping terminations clear and properly maintain the heater could result in property damage, severe personal injury, or death.

WARNING

For each floor containing bedroom(s), a carbon monoxide detector and alarm shall be placed in the living area outside the bedrooms, as well as in the room that houses the heater. Detectors and alarms shall comply with NFPA 720 (latest edition). Failure to comply with these requirements could result in product damage, severe personal injury, or death.

E. Exhaust Vent and Intake Pipe Sizing

Model	Intake Pipe		Exhaust Vent		Max. Total Equivalent Vent Length (Intake and Exhaust)	Input De-Rate Per 25' of Vent
	Intake Diameter	Intake Min. Length	Vent Diameter	Vent Min. Length		
1000	6"	16'	6"	16'	150'	2%
1700	8"		8"			

Table 10 - Exhaust Vent and Intake Pipe Sizing

1. The maximum total equivalent length of exhaust vent and intake pipe **should not exceed the lengths in Table 10.**

a. The equivalent length of elbows, tees, and other fittings are listed in the Friction Loss Table.

Friction Loss Equivalent in Piping and Fittings		
Fittings or Piping	Equivalent Feet	
	6"	8"
90 Degree Elbow*	3'	3'
45 Degree Elbow	1'	1'
Coupling	0'	0'
Air Inlet Tee	0'	0'
Straight Pipe	1'	1'
V Series Vent Kit	1'	1'
AL20 4c Vent Terminal	1'	1'

Table 11 - *Friction loss for long radius elbow is 1 foot less. NOTE: Consult Polypropylene venting instructions for friction loss and pressure drop equivalents.

b. For example: If the exhaust vent has two short 90° elbows and 10 feet of PVC pipe we will calculate:
 Exhaust Vent Equivalent Length = (2x3) + 10 = 16 feet.

Further, if the intake pipe has two 90° elbows, one 45° elbow, and 10 feet of PVC pipe, the following calculation applies:
 Intake Pipe Equivalent Length = (2x3) + 1 + 10 = 17 feet.

The total equivalent length is 43 feet, well below the maximum of 150 feet.

c. Effort should be made to keep a minimum difference in equivalent length between the exhaust vent and intake pipe.

2. The minimum total equivalent length is 16 feet.

CAUTION

Do not exceed the maximum lengths for vent pipes. Excessive length could result in boiler shutdown and property damage.

Failure to provide a minimum total vent length of 16 equivalent feet could result in property damage and improper product operation.

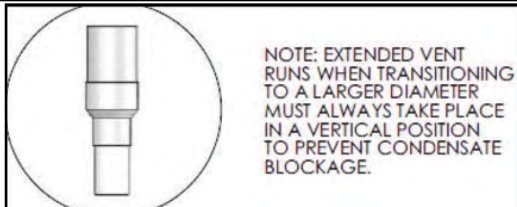

Figure 14 - Transitioning to Larger Diameter Pipe

F. Exhaust Vent and Intake Pipe Installation

WARNING

All joints of positive pressure vent systems must be sealed completely to prevent leakage of flue products into the living space. Failure to do so could result in property damage, serious injury, or death.

1. Use only solid PVC, CPVC, or stainless steel pipe or a Polypropylene vent system approved for use with Category IV appliances. FOAM CORE PIPING IS NOT APPROVED FOR EXHAUST VENT APPLICATIONS. Foam core piping may be used on air inlet piping **only**.
2. Remove all burrs and debris from joints and fittings.
3. When using PVC or CPVC pipe, all joints must be properly cleaned, primed, and cemented. Use only cement and primer approved for use with the pipe material. Cement must conform to ASTM D2564 for PVC and ASTM F493 for CPVC pipe. **NOTE: DO NOT CEMENT POLYPROPYLENE PIPE.**
4. Ensure the vent is located where it will not be exposed to prevailing winds.
5. In all roof venting applications, exhaust discharge must point away from the pitch of the roof.
6. If the exhaust vent is to be terminated in a walled off area (such as a roof with a parapet wall), ensure the exhaust vent terminates a minimum of 10' from nearest wall and extends level with or above the top of the wall. This will ensure flue gas does not get trapped and possibly recirculated into the intake air pipe, which could contaminate the combustion air.
7. To prevent water leakage, install adequate roof flashing where the pipe enters the roof.
8. Do not locate vent over public walkways, driveways, or parking lots. Condensate could drip and freeze, resulting in a slip hazard or damage to vehicles and machinery.
9. Due to potential moisture build-up, sidewall venting may not be the preferred venting option. To save time and cost, carefully consider venting installation and location.
10. Horizontal lengths of exhaust vent must slope back towards the boiler not less than 1/4" per foot to allow condensate to drain from the vent pipe.
11. The exhaust vent must terminate where vapors cannot make accidental contact with people or pets, or damage shrubs or plants.
12. In vacant chimney applications, install and seal a rain cap over existing chimney openings.
13. All piping must be fully supported. Use pipe hangers at a minimum of 4 foot intervals to prevent sagging of the pipe where condensate may form.
14. Do not use the boiler to support any piping.
15. Ensure the outdoor exhaust vent termination is screened to prevent blockage caused by debris or birds.
16. Ensure the outdoor intake pipe termination is screened to prevent blockage caused by debris or birds.
17. Maximum Snow Level Determination: These installation instructions reference snow levels in establishing a minimum height for the installation of exhaust vent or air intake terminations. Snow levels shall be determined as follows:
 - a. The installation location may, by ordinance, designate how snow levels are calculated in that location; or
 - b. In the absence of specific ordinances, snow levels shall be calculated from the average monthly maximum depth of snow

accumulation as indicated by the National Weather Service's 10 year statistics for the installation location/geographical area. In addition:

- Total length of vent piping shall not exceed the limits specified in this manual.
- The vent piping for this direct vented appliance is approved for zero clearance to combustible construction.
- The flue products coming from the exhaust vent will create a large plume when the heater is in operation. Avoid venting in areas that will affect neighboring buildings or be considered objectionable.
- DO NOT locate exhaust vent or intake pipe in a parking area where machinery may damage the pipe.
- DO NOT vent near soffit vents, crawl space vents, or other areas where condensate or vapor could create a nuisance or hazard or cause property damage.
- DO NOT vent where condensate vapor could cause damage or could be detrimental to the operation of regulators, relief valve, or other equipment.

In the Commonwealth of Massachusetts and as Required by State and Local Codes:

- The vented gas fueled appliance shall not be installed so its combustion, ventilation, or dilution air is obtained from a bedroom or bathroom.
- Signage: Whenever any through-the-wall (horizontal or sidewall) vent is installed less than seven feet above the finished grade, a metal or plastic identification plate shall be permanently mounted to the exterior of the building at a minimum height of eight feet above grade directly in line with the exhaust vent terminal. The sign shall read, in print no less than 0.5 inches in size, "GAS VENT DIRECTLY BELOW. KEEP CLEAR OF ALL OBSTRUCTIONS".
- Marking of Exhaust Vent and Intake Pipe: Piping used for ventilation, make-up, or combustion air intake shall be labeled as follows:
 - a. Throughout the entire developed length:
 - i. Labels must be placed every ten feet for exposed/visible piping; or
 - ii. Labels must be placed every three feet for concealed piping.
 - b. At all changes of direction;
 - c. On each side of a penetration through a partition, wall or ceiling; and
 - d. The labels shall be black lettering that:
 - i. Indicates that the piping is used for ventilation, make-up, or combustion air intake, and
 - ii. The letters shall be sized equal to a minimum of the pipe diameter. However, for piping with a diameter exceeding two inches, said lettering does not need to be larger than two inches.

G. Applications

1. Direct Vent Installation of Exhaust and Intake

If installing a direct vent option, combustion air must be drawn from the outdoors directly into the boiler intake, and exhaust must terminate outside. There are three basic direct vent options detailed in this manual: 1. Side Wall Venting, 2. Roof Venting, and 3. Unbalanced Venting.

Be sure to locate the boiler such that the exhaust vent and intake pipe can be routed through the building and properly terminated. Different vent terminals can be used to simplify and eliminate multiple penetrations in the building structure (see Optional Equipment in Venting Section). The exhaust vent and intake pipe lengths, routing and termination methods must all comply with the methods and limits given in the Venting section of this manual.

When installing a combustion air intake from outdoors, care must be taken to utilize uncontaminated combustion air. **NOTE:** To prevent combustion air contamination, see Table 1.

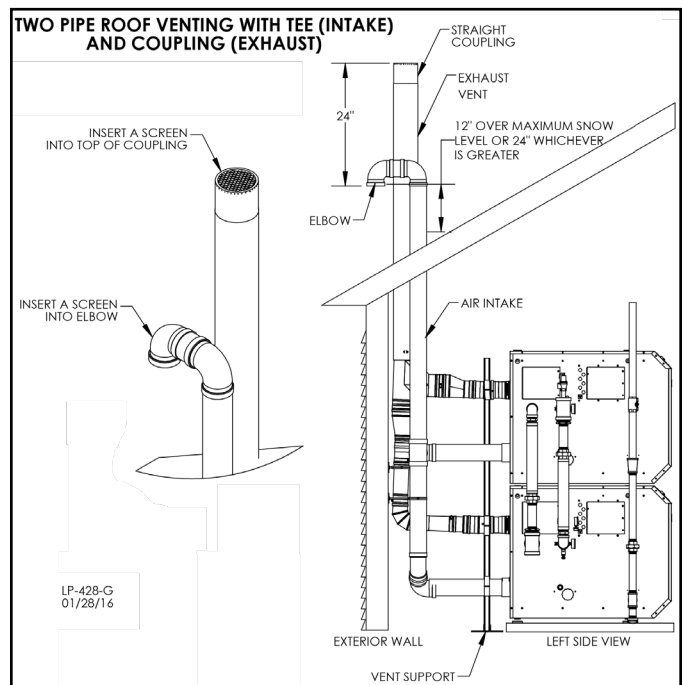
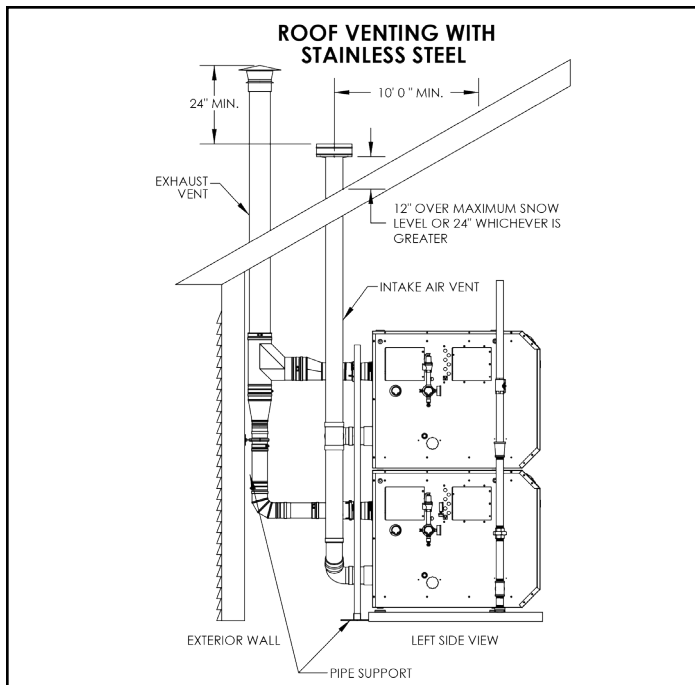

Figure 15 - Venting with Optional Kits (NOT INCLUDED WITH THE BOILER)

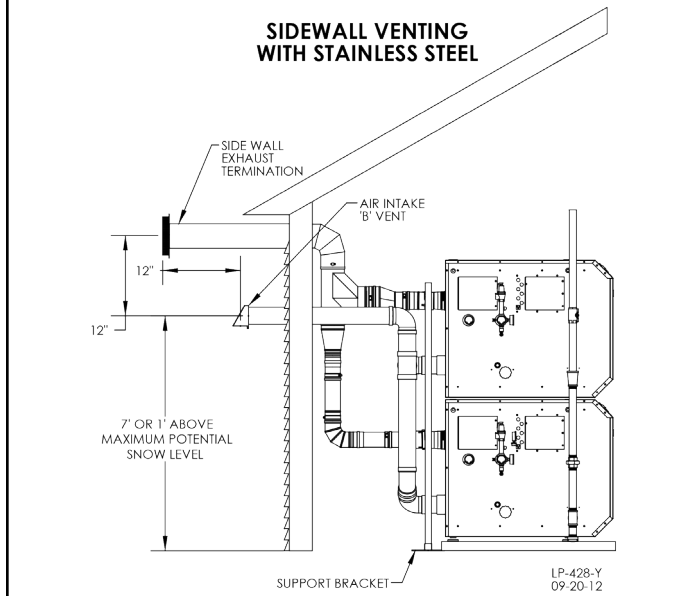

Figure 17 - Stainless Steel Two Pipe Roof and Sidewall Venting

NOTE: These drawings are meant to demonstrate system venting only. The installer is responsible for all equipment and detailing required by local codes.

WARNING

All vent pipes must be glued, properly supported, and the exhaust must be pitched a minimum of $\frac{1}{4}$ " per foot back to the boiler to allow drainage of condensate. Exhaust connection insertion depth should be a minimum of 2 $\frac{1}{2}$ " for 1000 models and 3" for 1700 models. When placing support brackets on vent piping, the first bracket must be within 1' of the appliance and the balance at 4' intervals on the vent pipe. Boiler venting must be readily accessible for visual inspection for the first three feet from the boiler.

Take extra precaution to adequately support the weight of vent pipes terminating through the roof. Failure to properly support roof terminated vent piping could result in property damage, serious personal injury, or death due to flue gas leakage.

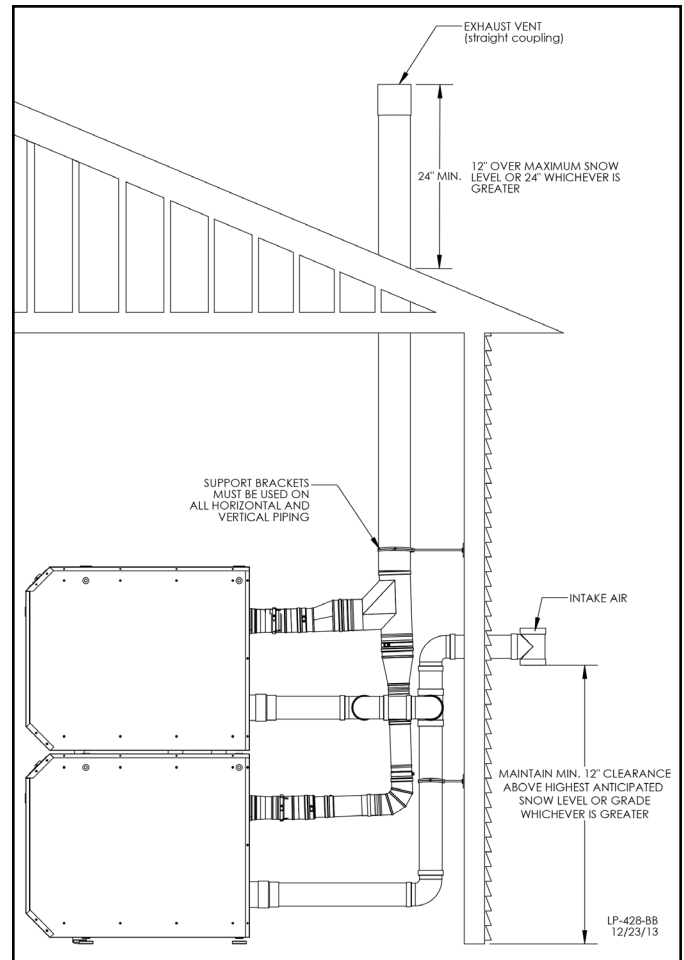

Figure 16 - Unbalanced Venting - Roof Exhaust and Sidewall Intake

WARNING

An unbalanced vent system can be installed **ONLY** when the exhaust is in the vertical position. Failure to do so could result in serious personal injury or death.

2. Room and Indoor Combustion Ventilation Requirements

When using an indoor combustion air installation, the mechanical room **MUST** be provided with properly sized openings, and/or be of sufficient volume to assure adequate combustion air and proper ventilation for all gas fired appliances in the mechanical room to assure adequate combustion air and proper ventilation. The requirements shown here are for the boiler only. Additional gas fired appliances in the mechanical room will require an increase in the net free area and/or volume to supply adequate combustion air for all appliances. This must be done in accordance with the National Fuel Gas Code, NFPA 54 / ANSI Z223.1.

This boiler can be vented using mechanical room air only for combustion. No combustion air openings are needed when the boiler is installed in a space with a volume **NO LESS** than 50 cubic feet per 1,000 BTU/hr of all installed gas fired appliances and the building **MUST NOT BE** of "Tight Construction".

TIGHT CONSTRUCTION: A building with less than .4 ACH (air changes per hour). For buildings of "Tight Construction", provide air openings into the building from the outside.

Indoor and outdoor combustion air may be combined by applying a ratio of available volume to required volume times the required outdoor air opening(s) size(s). This must be done in accordance with the National Fuel Gas Code, NFPA 54 / ANSI Z223.1.

1. If air is taken directly from outside the building with no duct, provide two permanent openings to the mechanical room each with a net free area of one square inch per 4000 BTU/hr input. See Figure 18.
2. If combustion and ventilation air is taken from the outdoors using a duct to deliver the air to the mechanical room, each of the two openings should be sized based on a minimum free area of one square inch per 2000 BTU/hr input. See Figure 19.
3. If air is taken from another interior space combined with the mechanical room:

- a. Two spaces on same story: Each of the two openings specified should have a net free area of one square inch for each 1000 BTU/hr input, but not less than 100 square inches.
- b. Two spaces on different stories: One or more openings should have a net free area of two square inches per 1000 BTU/hr.

See Figure 20 for reference.

4. If a single combustion air opening is provided to bring combustion air in directly from the outdoors, the opening must be sized based on a minimum free area of one square inch per 3000 BTU/hr. This opening must be located within 12" of the top of the enclosure. See Figure 21.

Combustion air requirements are based on the latest edition of the National Fuel Gas Code, NFPA 54 / ANSI Z223.1, CGA Standard CAN/CSA B149.1 in Canada. Check all local code requirements for combustion air.

All dimensions based on net free area in square inches. Metal louvers or screens reduce the free area of a combustion air opening a minimum of approximately 25%. Check with louver manufacturers for exact net free area of louvers.

Where two openings are provided, one must be within 12" of the ceiling, and one must be within 12" of the floor of the mechanical room. Each opening must have a net free area as specified in Table 12. Single openings shall commence within 12" of the ceiling. The minimum dimension of air openings should not be less than 3".

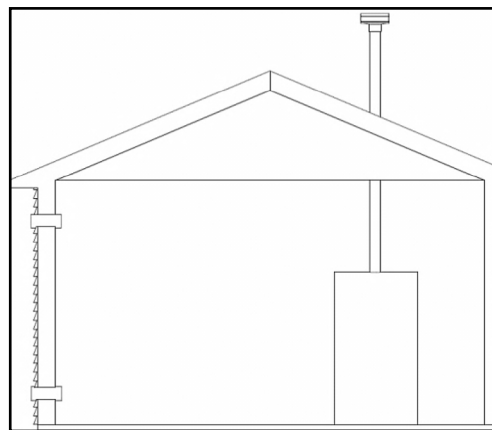

Figure 18 - Combustion Air from Outdoors

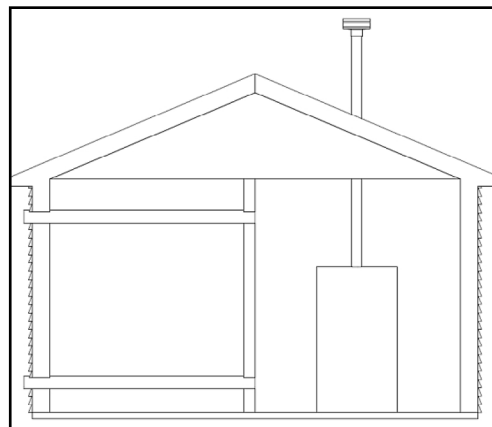

Figure 19 - Combustion Air through Ductwork

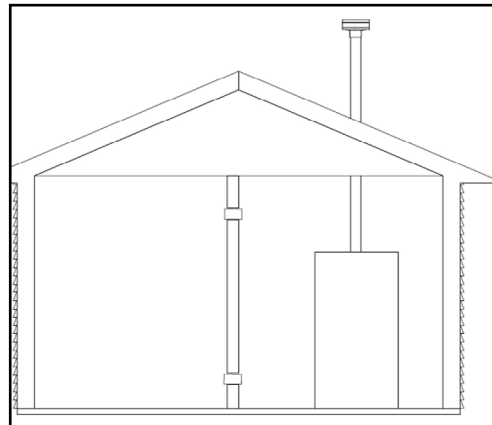

Figure 20 - Combustion Air from Indoors

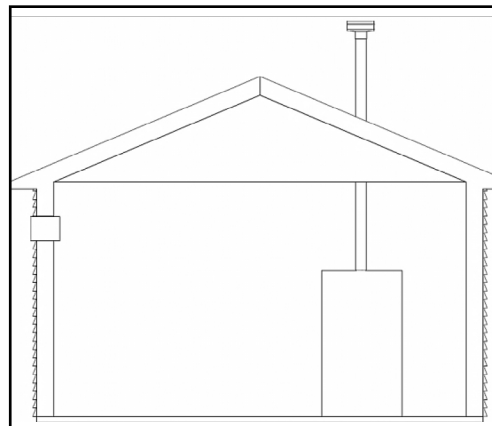

Figure 21 - Combustion Air from Outdoors - Single Opening

CAUTION

Under no circumstances should the mechanical room ever be under negative pressure. Particular care should be taken where exhaust fans, attic fans, clothes dryers, compressors, air handling units, etc., may take away air from the unit. Failure to follow these instructions could result in property damage or personal injury.

Combustion air supply must be completely free of any flammable vapors that may ignite, or chemical fumes which may be corrosive to the boiler. See Table 1 for a list of combustion air contaminants. These chemicals, when burned, form acids which quickly attack the stainless steel heat exchanger, headers, flue connectors, and the vent system. The result is improper combustion and premature boiler failure. Such failure IS NOT covered under warranty.

EXHAUST FANS: Any fan or appliance which exhausts air from the mechanical room may deplete the combustion air supply and/or cause a downdraft in the venting system. Spillage of flue products from the venting system into an occupied living space can cause a very hazardous condition that must be corrected immediately.

Minimum Recommended Combustion Air Supply to Mechanical Room				
Model	Figure 18		Figure 19	
	*Outside Air from 2 Openings Directly from Outdoors ¹		*Outside Air from 2 Ducts Delivered from Outdoors ¹	
	Top Opening, in ²	Bottom Opening, in ²	Top Opening, in ²	Bottom Opening, in ²
1000	250	250	500	500
1700	425	425	850	850
Model	Figure 20			Figure 21
	Inside Air from 2 Ducts Delivered from Interior Space ²			*Outside Air from 1 Opening Directly from Outdoors, in ² ¹
	Same Story		Different Stories	
	Top Opening, in ²	Bottom Opening, in ²	Top Opening, in ²	
1000	1000	1000	2000	335
1700	1700	1700	3400	570

Table 12 - Indoor Combustion Air Sizing

The above requirements are for the boiler only; additional gas fired appliances in the mechanical room will require an increase in the net free area and/or volume to supply adequate combustion air for all appliances.

No combustion air openings are needed when the boiler is installed in a space with a volume NO LESS than 50 cubic feet per 1,000 BTU/hr of all installed gas fired appliances. Buildings MUST NOT be of *Tight Construction*.

¹Outside air openings shall communicate with the outdoors.

²Combined interior space must be 50 cubic feet per 1,000 BTU/hr input. Buildings MUST NOT be of *Tight Construction*.

Part 6 - Condensate Removal

NOTE: Check with your local gas company to determine if combustion condensate disposal is permitted in your area. In the state of Massachusetts, condensate must be neutralized before entering a drain.

This boiler is a high efficiency appliance, and therefore produces condensate: a by-product of the combustion process. A condensate collection system with an internal float switch monitors condensate level to prevent it from backing up into the combustion system. There is a 3/4" socket connection provided to connect the outlet of the collection system to a drain or condensate pump.

Condensate from the boiler is slightly acidic with a pH of 3.2 - 4.5. To avoid long term damage to the drainage system and to meet local code requirements, HTP recommends neutralizing condensate with a Condensate Neutralizer Kit (Part # 7350P-611). The neutralizer kit connects to the drain system and contains limestone chips that neutralize the pH level of the condensate. The neutralizer kit should be checked annually and the limestone chips replenished if necessary. When replacing the limestone chips, take care to ensure chips are no smaller than 1/2" to avoid blockage in condensate piping (refer to figure below for piping of the condensate neutralizer.)

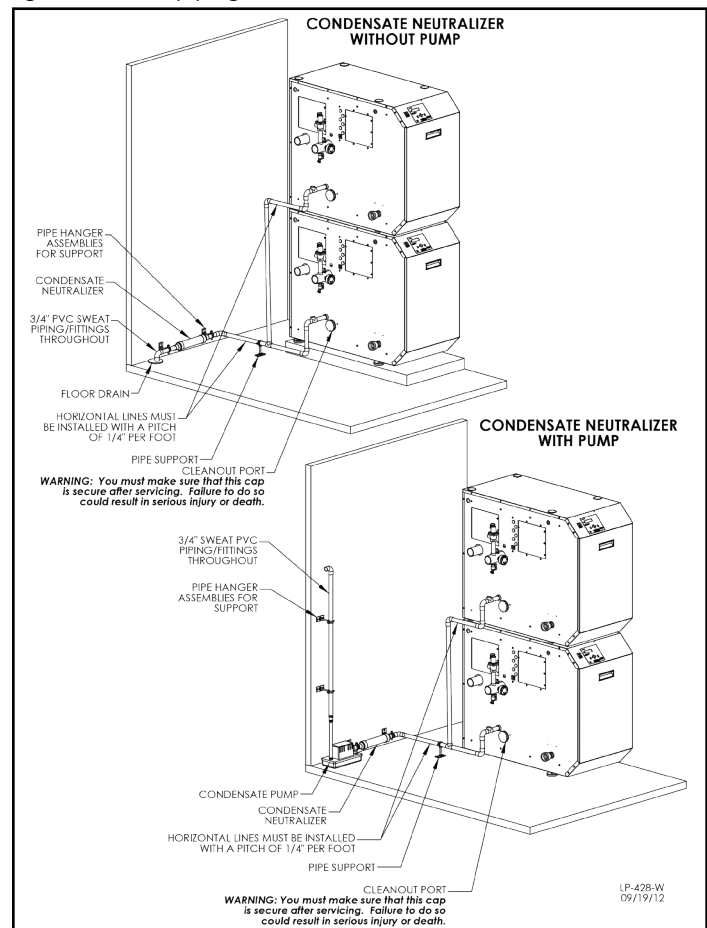

Figure 22 - Condensate Piping

NOTES:

1. Condensate line must be pitched at least 1/4" per foot to properly drain. If this cannot be done, or a very long length of condensate hose is used, increase the condensate line to a minimum of 1" ID and place a tee in the line after the condensate neutralizer to properly reduce vacuum lock in the drain line.
2. PVC or CPVC pipe should be the only material used for condensate line. Steel, brass, copper, and other metals will be subject to corrosion or deterioration.
3. A frozen condensate line could result in a blocked vent condition. It is very important to protect the condensate line from freezing

temperatures or any type of blockage. In installations that may encounter sustained freezing conditions, the use of heat tape is recommended to avoid freezing of the condensate line. It is also recommended to bush up the condensate line size to 1" and terminate condensate discharge as close to the unit as possible. Longer condensate runs are more prone to freezing. Damages due to frozen or blocked condensate lines ARE NOT covered by warranty.

4. Support of the condensate line may be necessary to avoid blockage of the condensate flow.

5. To allow proper drainage on longer horizontal condensate runs, tubing size may need to increase to 1" and a second line vent may be required.

NOTE: To clean out condensate trap, see Maintenance section.

CAUTION

The condensate line must remain unobstructed. If allowed to freeze in the line or obstructed in any other manner, condensate can exit from the boiler tee, resulting in potential water damage to property. When installing a condensate pump, select one approved for use with condensing boilers and furnaces. The condensate pump should have an overflow switch to prevent property damage from spillage. Condensate from the boiler will be slightly acidic (pH from 3.2 to 4.5). Install a neutralizing filter if required by local codes.

It is very important that condensate piping be no smaller than 3/4". Use a tee at the condensate connection with a branch vertically up and open to the atmosphere to prevent a vacuum that could obstruct the flow of condensate from the boiler. To prevent sagging and maintain pitch, condensate piping should be supported with pipe supports.

When installing a condensate pump, select one approved for use with condensing boilers and furnaces. The pump should have an overflow switch to prevent property damage from condensate spillage.

WARNING

Power to the optional condensate pump is continuous. When the boiler is powered off the condensate pump will remain on. It is important to remember to turn off the condensate pump when powering down the boiler. Failure to do so could result in property damage, severe personal injury, or death.

Part 7 - Wiring

WARNING

To avoid electrical shock, turn off all power to the boiler prior to opening an electrical box within the unit. Ensure the power remains off while any wiring connections are being made. Failure to follow these instructions could result in component or product failure, serious injury, or death. Such product failure IS NOT covered by warranty.

Jumping out control circuits or components WILL VOID product warranty and can result in property damage, personal injury, or death.

Electrical Shock Hazard - Turn off electrical power supply at service entrance panel before making any electrical connections. Failure to follow do do so could result in serious injury, or death.

It is of extreme importance that this unit be properly grounded. It is very important that the building system ground is inspected by a qualified electrician prior to making this connection. Electrical power must only be turned on when the boiler is completely filled with cold water. Failure to follow these instructions could result in component or product failure, serious injury, or death.

CAUTION

Label all wires prior to disconnecting them when servicing the boiler. Wiring errors can cause improper and dangerous operation. Failure to follow these instructions may result in property damage or personal injury.

CAUTION

Wiring must be NEC Class 1. If original wiring supplied with the boiler must be replaced, use only TEW 105 °C wire or equivalent. Boiler must be electrically grounded as required by the National Electrical Code, ANSI/NFPA 70 - Latest Edition.

Each boiler controller can pull a maximum of 6.3 amps at 120V. For 1000 and 1700 models, this is a maximum of 12.6 amps combined. It is recommended to wire each boiler to a dedicated minimum 15 amp circuit.

A. Installation Must Comply With

1. National Electrical Code and any other national, state, provincial, or local codes or regulations.
2. In Canada, CSA C22.1, Canadian Electrical Code Part 1, and any local codes.

B. Field Wiring Terminations

All connections made to the boiler in the field are done inside the electrical junction box located on the left side of the unit. Multiple knockout locations are available to route field wires into and out of the electrical junction box.

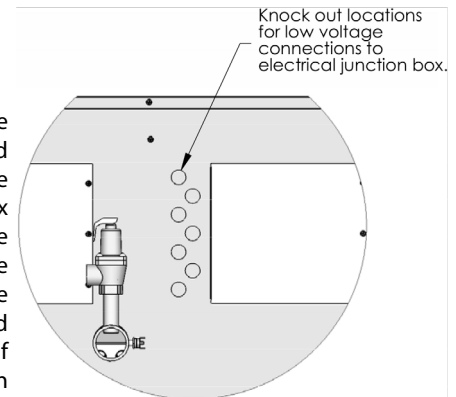

Figure 23 - Knockout Locations

C. Field Wiring

CAUTION

Check water chemistry section for acceptable levels. If water chemistry is acceptable, pumps may be wired directly to pump terminals. If water chemistry levels are too high, you must wire pumps to line voltage to run continuously to prevent lime buildup.

The control used in these boilers is capable of directly controlling 3 pumps as configured. Each pump output can provide a maximum of 3 amps at 120 volts. This output is sufficient to operate the coil of a motor starter correctly sized for the pump or pumps used in this system design.

The electrical junction box has separate, clearly marked terminal strips for line voltage and low voltage wiring. Special jacks are provided for trouble-free cascade system wiring using standard CAT3 or CAT5 patch cables.

D. Line Voltage Wiring

1. Connect the incoming power wiring to the line voltage terminal strip in the electrical junction box at terminals 120V, Neutral, Ground of the bottom boiler (shown in Figure 24).
2. A line voltage fused disconnect switch may be required, externally mounted and connected according to local codes that may apply.
3. Connect the central heating pump motor starter coil to the terminals marked BOILER HOT, BOILER NEUT, and BOILER GRD in the bottom boiler.
4. If using DHW, connect the domestic hot water pump to the terminals marked DHW HOT, DHW NEUT, DHW GND on the bottom boiler. The connections shown are suitable for a maximum

continuous pump draw of 3 amps at 120 volts. If a pump requires more current or voltage than the 120 volts supplied, an external motor starter or contactor will be required.

E. Alarm Connections (Top Boiler Connection)

The control includes a dry contact alarm output. This is an SPDT circuit, rated at 5 amps at 120 volts. This contact can be used to activate an alarm light or bell or notify a building management system if the boiler goes into a lockout condition. The circuit between the ALARM COM and NC terminals is closed during normal operation and the circuit between ALARM COM and NO is open during normal operation. The connections depicted in Figure 24 show two 120 volt lights connected to the alarm terminals. One light will be on when the boiler is in normal mode and the other light will be on when the boiler is in lockout mode.

F. Low Voltage Connections for Standard Boiler

1. All low voltage cables should enter the electrical junction box through the provided knock out holes as shown in Figure 23.
2. Connect all low voltage field devices to the low voltage terminal strip located in the electrical junction box.

G. Thermostat

1. Connect the room thermostat to the terminals marked THERMOSTAT in the electrical junction box (shown in Figure 24). Alternately, any dry contact closure across these terminals will cause the boiler to run. Caution should be taken to ensure neither of the terminals becomes connected to ground.
2. Mount the thermostat on an inside wall as centrally as possible to the area being heated, but away from drafts or heat producing devices such as television sets that could influence the ability of the thermostat to measure room temperature.
3. If the thermostat is equipped with an anticipator and it is connected directly to the Mod Con boiler, the anticipator should be set at .1 amps. If the thermostat is connected to other devices, the anticipator should be set to match the power requirements of the device it is connected to. See the instruction manual of the connected devices for further information.

H. Outdoor Sensor

1. There is no connection required if an outdoor sensor is not used in this installation.
2. If using an outdoor sensor, connect wires for sensor to the terminals marked OUTDOOR SEN (shown in Figure 24) in the electrical junction box of the bottom boiler. Caution should be used to ensure neither of these terminals becomes connected to ground.
3. Use a minimum 22 AWG wire for runs of 100 feet or less and minimum 18 AWG wire for runs of up to 150 feet.
4. Mount the outdoor sensor on an exterior surface of the building, preferably on the north side in an area that will not be affected by direct sunlight and will be exposed to varying weather conditions.

I. Indirect Sensor (Top Boiler Connection)

1. There is no connection required if an indirect water heater is not used in this installation.
2. The boiler will operate an indirect fired water heater with either a thermostat type aquastat installed in the indirect tank, or an HTP 7250P-325 tank sensor. When a tank sensor is used, the control will automatically detect its presence and a demand for heat from the indirect water heater will be generated when the tank temperature falls below the user selected set point by more than the user selected offset. The demand will continue until the sensor measures that the indirect water heater temperature is above the set point.
3. Connect the indirect tank sensor (7250P-325) to the terminals marked DHW SENSOR (shown in Figure 24) in the electrical junction box of the top boiler.

WARNING

Failure to use the correct sensor may result in tank temperature being either above or below set point, and could result in decreased performance, substantial property damage, or heightened risk of injury or death due to scalds.

Caution should be used to ensure neither of these terminals becomes connected to ground.

NOTE: If sensor wires are located in an area with sources of potential electromagnetic interference (EMI), the sensor wires should be shielded, or the wires routed in a grounded metal conduit. If using shielded cable, the shielding should be connected to the common ground of the boiler.

J. Optional 0-10 Volt Building Control Signal

1. A signal from a building management system may be connected to the boiler to enable remote control. This signal should be a 0-10 volt positive-going DC signal. When this input is enabled using the installer menu, a building control system can be used to control the set

point temperature of the boiler. The control interprets the 0-10 volt signal as follows; when the signal is between 0 and 1.5 volts, the boiler will be in standby mode, not firing. When the signal rises above 1.5 volts, the boiler will ignite. As the signal continues to rise towards its maximum of 10 volts, the boiler will increase in set point temperature. See Part 10 for details on the setting of parameters 16 and 17.

2. Connect a building management system or other auxiliary control signal to the terminals marked 16, 0-10 VOLT + and 17, 0-10 VOLT - in the electrical junction box (shown in Figure 24). Caution should be used to ensure that the 0-10 VOLT + connection does not become connected to ground.

K. Optional High Gas Pressure Switch

1. If an optional high gas pressure switch is used, it should be installed on the outlet side of the gas valve of both boilers. This is normally closed and will open if the pressure goes above 1.5" w.c. on the outlet side.
2. Locate the two pigtailed hanging from the electrical box inside of the boiler cabinet. Remove and discard the jumper plug from one of the unused pigtailed.
3. Connect the high gas pressure switch to the pigtail that you removed the jumper plug from.

L. Optional Low Gas Pressure Switch

1. If an optional low gas pressure switch is used, it should be installed on the inlet side of the gas valve of both boilers. This is normally closed and will open if the pressure goes below 1" w.c. on the inlet side.
2. Locate the two pigtailed hanging from the electrical box inside of the boiler cabinet. Remove and discard the jumper plug from one of the unused pigtailed.
3. Connect the low gas pressure switch to the pigtail that you removed the jumper plug from.

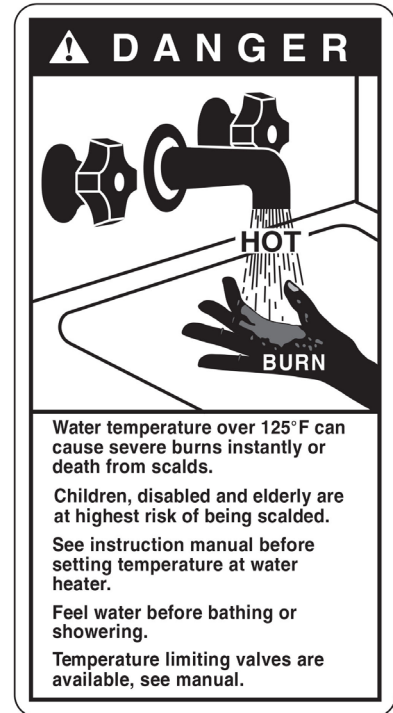

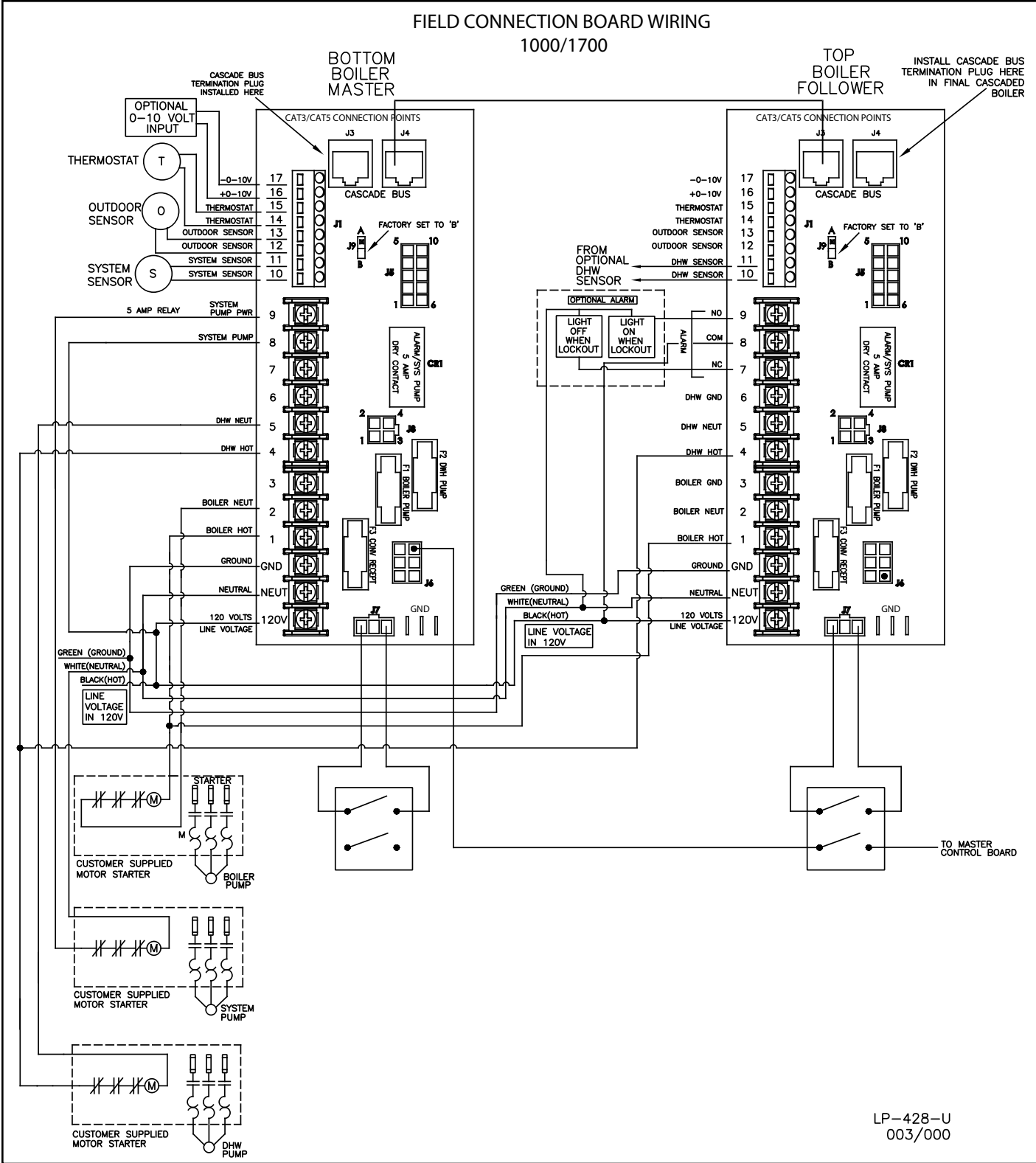

Figure 24 - Cascade Master and Follower Wiring

M. Optional Flow Switch

NOTE: Follow the more detailed instructions included with the flow switch kit for proper installation steps.

NOTE: The boiler requires two (2) flow switches to ensure there is enough flow through each heat exchanger of the boiler assembly.

1. Attach the correct flow paddle to the flow switch.
2. Thread brass tee onto outlet nipple using pipe dope. **Make certain the branch points up on horizontal runs.**
3. Thread flow switch into tee using pipe dope. **Make certain the FLOW arrow points in the correct direction.**

4. Disconnect red wire on the low water cut off probe and connect it to the red wire from the wire harness (included in kit).
5. Feed green ground wire into boiler through the wire access.
6. From the front of the boiler, feed the ground wire up into the control box.
7. Once into the control box, attach the green ground to the ground bus connection.
8. Connect red wire from flow switch to boiler wire harness.
9. When installation is complete, power up the boiler and use the control to access installer parameter #20 and change the default value to 2 (see Part 10 in this manual). When done, create a demand and

the gas pressure switch to the remaining connector from the LWCO control box.

O. Wiring of Cascade System Communication Bus

NOTE: A termination plug is included in the CAT 3 / CAT 5 Bus Connection Point labeled J3 in Figure 24. DO NOT REMOVE THIS PLUG UNLESS INSTRUCTED TO DO SO. Doing so will affect boiler operation and void warranty.

1. A Cascade Bus Termination Plug has been installed on the customer connection board of this boiler. The purpose of this plug is to stabilize communication between multiple boilers and reduce electrical "noise". See Figure 27 for Cascade Bus Termination Plug installation detail.
2. Use standard CAT3 or CAT5 computer network patch cables to connect the communication bus between each of the boilers. The cable must be of the "straight through" design. These cables are readily available at any office supply, computer, electronic, department or discount home supply store in varying lengths. If you possess the skills you can also construct custom length cables.
3. It is recommended to use the shortest length cable that will reach between the boilers and create a neat installation. Do not run unprotected cables across the floor where they may become wet or damaged. Avoid running communication cables parallel and close to or against high voltage (120 volt or greater) wiring. HTP recommends that the maximum length of communication bus cables not exceed 200 feet.
4. Route the communication cables through one of the knockouts in the cabinet.
5. Connect the boilers in a daisy chain configuration as shown below.

It is best to wire the boilers using the shortest wire runs rather than trying to wire them in the order that they are addressed. The communication bus jacks on the customer connection panel are interchangeable so you can use either one or both in any order to connect the cable.

If you have connected the boilers to each other properly, there will be no open communication connection ports.

Part 8 - Gas Connections

WARNING

Failure to follow all precautions could result in fire, explosion, severe injury, or death.

It is very important that you are connected to the type of gas noted on the rating plate. "LP" for liquefied petroleum, propane gas, or "NG" for natural or city gas. Do not do a gas conversion without an approved gas conversion kit. Prior to turning the gas on, all gas connections must be approved by the local gas supplier or utility, in addition to the governing authority. A gas conversion kit comes with 1000 model boilers ONLY. Field conversions ARE NOT ALLOWED on the 1700 model. A properly calibrated combustion analyzer must be used to verify proper combustion. Failure to follow the above instructions could result in property damage, serious injury, or death.

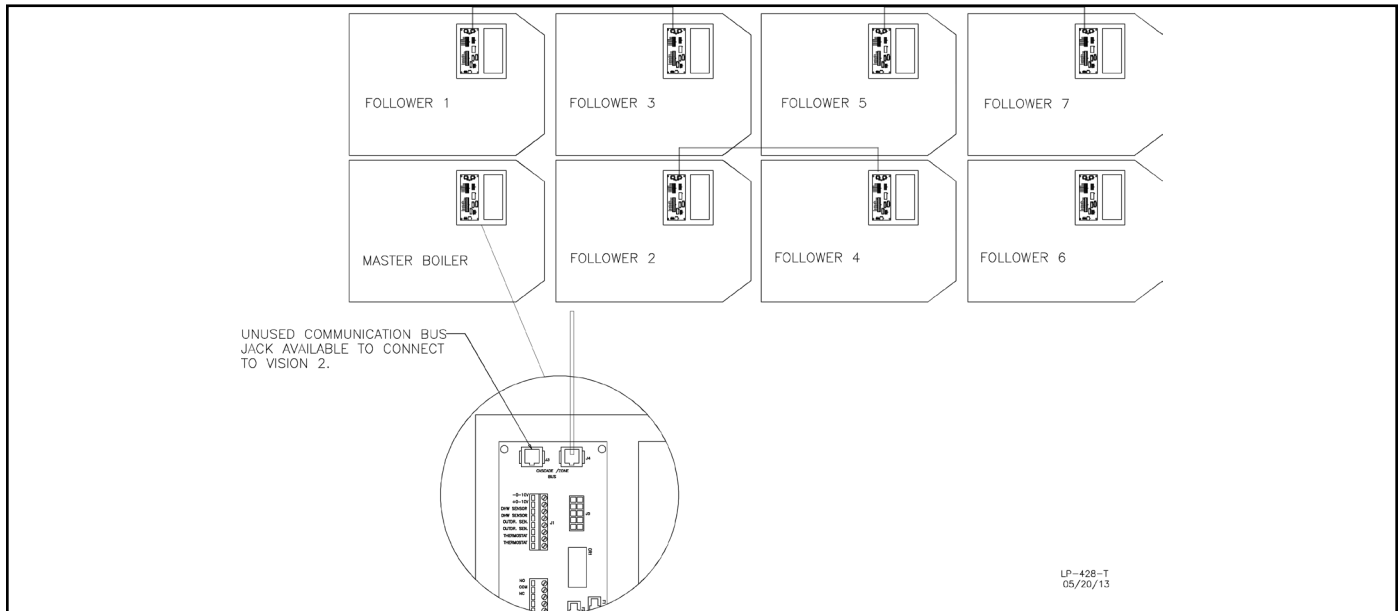

Figure 26 - Wiring Cascade System

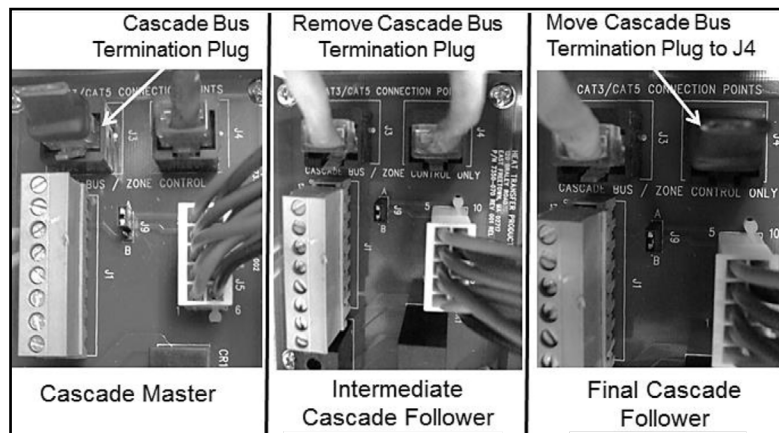

Figure 27 - Cascade Termination Plug Detail

The gas supply shall have a minimum of no less than 3.5" water column, a maximum inlet pressure of no greater than 14" water column (350 mm), and ½ pound pressure (3.5 kPa). The entire piping system, gas meter, and regulator must be sized properly to prevent excessive pressure drop (greater than 0.5" WC) as stated in the National Fuel Gas Code. This information is listed on the rating plate.

WARNING

UL recognized fuel gas detectors are recommended in all enclosed propane and natural gas applications where there is a potential for an explosive mixture of fuel gas to accumulate. The installation of these detectors should be made in accordance with the detector manufacturer's recommendations, and/or local laws. Failure to install fuel gas detectors in these applications could result in fire, explosion, property damage, severe personal injury, or death.

The gas connection on the boiler is 2" for the 1000 model and 2 1/2" for the 1700 model. It is mandatory that this fitting is used for connection to a field fabricated drip leg as shown in the illustration per the National Fuel Gas Code. You must ensure the entire gas line to the connection at the boiler is no smaller than the unit supplied connection.

Once all inspections have been performed, the piping must be leak tested. If the leak test requirement is a higher test pressure than the maximum inlet pressure, you must isolate the boiler from the gas line. In order to do this, shut the gas off using factory and field-installed gas cocks. This will prevent high pressure. Failure to do so may damage the gas valve. In the event the gas valve is exposed to a pressure greater than ½ PSI, 14" w.c. (3.5 kPa), the gas valve must be replaced. Never use an open flame (match, lighter, etc.) to check gas connections.

A. Gas Piping

1. Run the gas supply line in accordance with all applicable codes.
2. Locate and install manual shutoff valves in accordance with state and local requirements.
3. In Canada, the Manual Shutoff must be identified by the installing contractor.
4. It is important to support gas piping as the unit is not designed to structurally support a large amount of weight.
5. Purge all gas lines thoroughly to avoid start up issues with air in the lines.
6. Sealing compound must be approved for gas connections. Care must be taken when applying compound to prevent blockage or obstruction of gas flow which may affect the operation of the unit.

WARNING

Support gas supply piping with hangers, not by the boiler or its accessories. The boiler gas valve and blower will not support the weight of the piping. Make sure the gas piping is protected from physical damage and freezing, where required. Failure to follow these instructions could result in gas leakage, and result in fire, explosion, property damage, severe personal injury, or death.

Never use an open flame (match or lighter) to check for gas leaks. Use a soapy solution to test connection. Failure to use a soapy solution test or check gas connection for leaks can result in substantial property damage, severe personal injury, or death.

Do not use Teflon tape on gas line pipe thread. Use a pipe compound rated for use with natural and propane gases. Apply sparingly on male pipe ends, leaving the two end threads bare and flow unobstructed. Failure to follow these instructions could result in gas leakage or blockage, and result in fire, explosion, property damage, severe personal injury, or death.

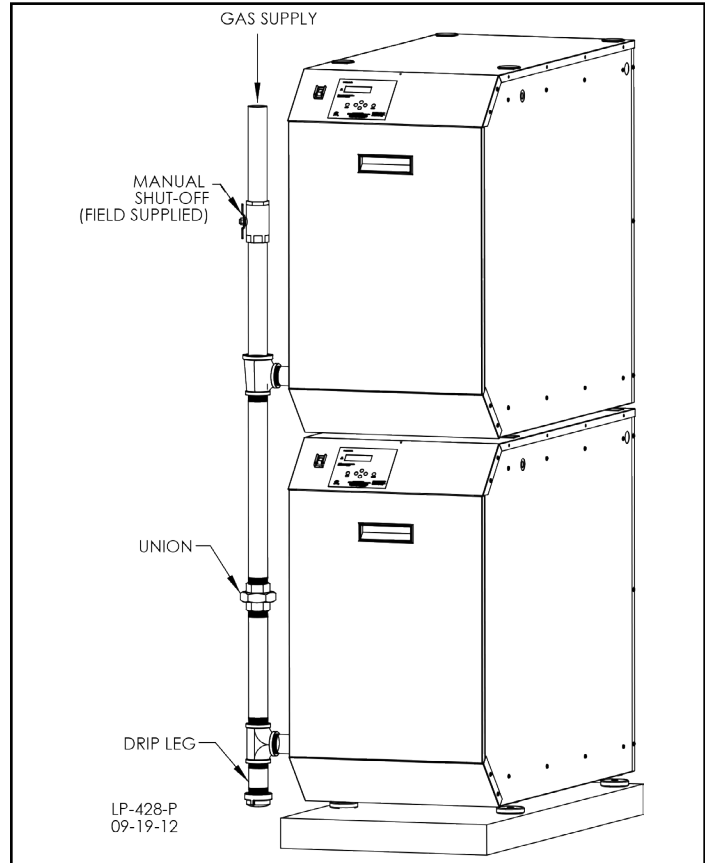
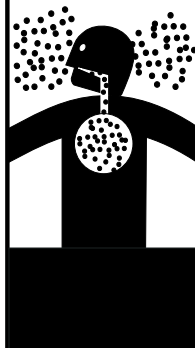

Figure 28 - Gas Connection

WARNING

Breathing Hazard - Carbon Monoxide Gas



- Do not operate heater if flood damaged.
- Install vent system in accordance with local codes and manufacturers installation instructions.
- Do not obstruct heater air intake or exhaust. Support all vent piping per manufacturers installation instructions.
- Do not place chemical vapor emitting products near unit.
- According to NFPA 720, carbon monoxide detectors should be installed outside each sleeping area.
- Never operate the heater unless it is vented to the outdoors.
- Analyze the entire vent system to make sure that condensate will not become trapped in a section of vent pipe and therefore reduce the open cross sectional area of the vent.

Breathing carbon monoxide can cause brain damage or death. Always read and understand instruction manual.

LP-304

CAUTION

Use two wrenches when tightening gas piping at the boiler: One to prevent the boiler gas line from turning. Failure to prevent the boiler gas connection from turning could result in damage to the gas line components, substantial property damage, severe personal injury, or death.

CSA or UL listed flexible gas connections can be used when installing the boiler. Flexible gas connections have different capacities and must be sized correctly for the connected boiler firing rates. Consult with the flex line supplier to assure the line size is adequate for the job. Follow local codes for proper installation and service requirements.

B. Gas Table

Refer to Table 13 to size the supply piping to minimize pressure drop between the meter or regulator and unit. Maximum capacity of pipe in cubic feet of gas per hour for gas pressures of .5 w.c. or less and a pressure drop of .3 inch w.c.

Natural Gas Supply Piping Capacity Chart				
(0.6 Specific gravity gas; 0.5"WC pressure drop) *Schedule 40 iron pipe size in nominal inches				
Model	1 Unit	2 Units	3 Units	4 Units
1000 @ 100' of Pipe	2"	3"	3"	4"
1000 @ 250' of Pipe	2 1/2"	3"	4"	4"
Model	1 Unit	2 Units	3 Units	4 Units
1700 @ 100' of Pipe	2 1/2"	4"	4"	5"
1700 @ 250' of Pipe	3"	4"	5"	5"

Table 13 - Gas Supply Piping Size Chart for Boilers

C. Check Inlet Gas Pressure

The gas valve is equipped with an inlet gas pressure tap that can be used to measure the gas pressure to the unit. To check gas pressure, perform the steps listed below:

1. **IMPORTANT!** Before you connect to the inlet pressure, shut off the gas and electrical power to unit.
2. Loosen the pressure tap with a small screwdriver. Refer to Figures 29 and 30 for location.
3. Each unit is equipped with a needle valve that will accept a 5/16 ID hose to connect to a digital manometer or liquid gauge to measure incoming pressure from 0-35" w.c.
4. Turn on the gas and power up the unit.
5. Put the unit into manual test mode (details on test mode in Part 10). In test mode, monitor pressure to assure it does not drop below 1 inch from its idle reading. If gas pressure is out of range or pressure drop is excessive, contact the gas utility, gas supplier, qualified installer, or service agency to determine correct action that is needed to provide proper gas pressure to the unit. If Gas Pressure is within normal range proceed to Step 6.
6. Exit test mode, then turn power off and shut off gas supply at the manual gas valve before disconnecting the hose from the gas monitoring device. Tighten screw on the pressure tap and turn gas on. Check for leaks with soapy solution. Bubbles will appear on the pipe to indicate a leak is present.

 WARNING
Ensure the pressure tap screw is properly tightened to prevent gas leaks. Failure to do so could cause substantial property damage, severe personal injury, or death.

The gas piping must be sized for the proper flow and length of pipe to avoid pressure drop. The gas meter and regulator must be properly sized for the total gas load. If you experience a pressure drop greater than 1" w.c. (.87 kPa), the meter, regulator or gas line may be undersized or in need of service. You can attach a manometer to the incoming gas drip leg after removing the cap. The gas pressure must remain between 3.5" (.87 kPa) and 14" (3.5 kPa) during stand-by (static) mode and while in operating (dynamic) mode.

If an in-line regulator is used, it must be a minimum of 10 feet from the boiler. It is very important that the gas line is properly purged by the gas supplier or utility. Failure to properly purge the lines, or improper line sizing, will result in ignition failure. This problem is especially noticeable in NEW LP installations and empty tank situations. This situation can also occur when a utility company shuts off service to an area to provide maintenance to their lines. This gas valve must not be replaced with a conventional gas valve under any circumstances.

 WARNING
DO NOT adjust or attempt to measure gas valve outlet pressure. The gas valve is factory-set for the correct outlet pressure and requires no field adjustment. Attempts by the installer to adjust or measure the gas valve outlet pressure could result in damage to the valve and cause substantial property damage, severe personal injury, or death.
Strain on the gas valve and fittings may result in vibration, premature component failure and gas leakage, and result in fire, explosion, property damage, severe personal injury, or death.
Adjustments to the throttle screw or offset may only be made by a qualified gas technician using a calibrated combustion analyzer capable of measuring CO2 and CO. Failure to follow this instruction could result in fire, explosion, property damage, severe personal injury, or death.
Ensure that the high gas pressure regulator is at least 6 – 10 feet upstream of the appliance. Failure to do so could result in substantial property damage, severe personal injury, or death.

 DANGER
Do not do a gas conversion on this boiler without an officially approved conversion kit and instructions supplied by HTP. Failure to use a conversion kit when converting the boiler to fire on Natural or Propane gas will result in extremely dangerous burner operation, leading to fire, explosion, severe personal injury, or death.

Natural or LP Gas	
Minimum Pressure	3.5"WC
Maximum Pressure	14"WC

Table 14 - Gas Pressure Requirements

NOTICE
Do not fire (operate) the boiler until all connections have been completed and the heat exchanger is filled with water. Doing so will damage the boiler and void the warranty.

D. Boiler Gas Valve

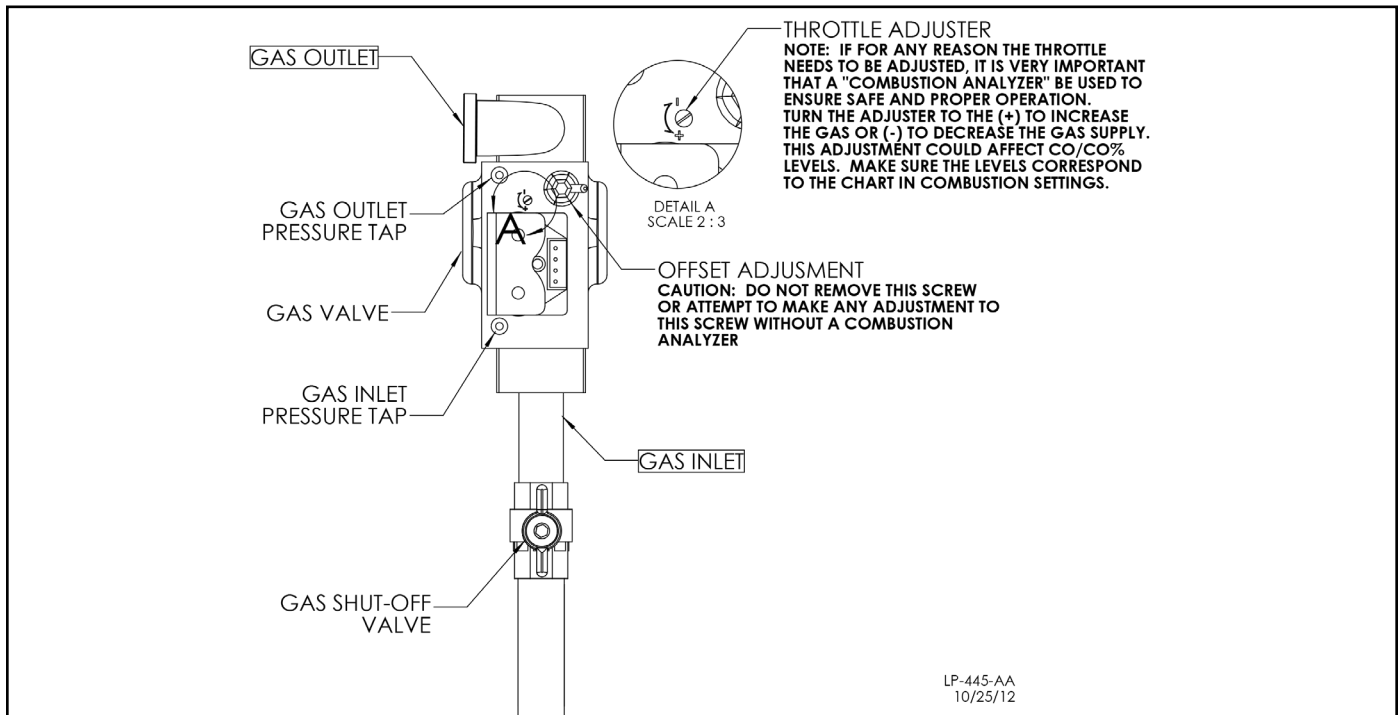

Figure 29 - 1000 Model Gas Valve

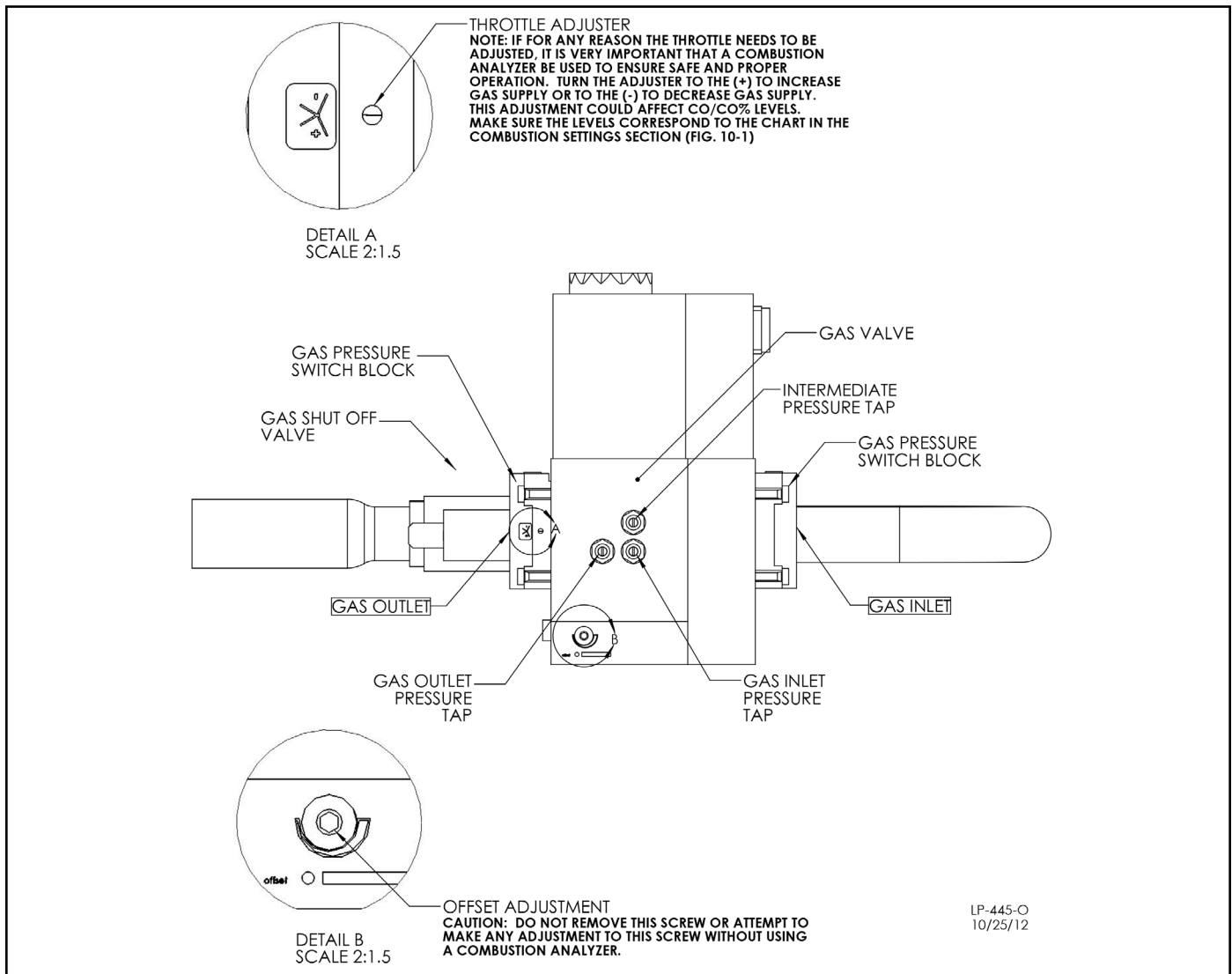

Figure 30 - 1700 Model Gas Valve

Part 9 - Start-Up Preparation

WARNING

Thoroughly clean and flush any system that has used glycol before installing the boiler. Provide the customer with a material safety data sheet (MSDS) on the fluid used.

A. Check / Control Water Chemistry

CAUTION

Chemical imbalance of your water can cause severe damage to your boiler and associated equipment, and may also affect efficiency. You may have to have your water quality professionally analyzed to determine whether you need to install a water softener. It is important that the water chemistry on both the domestic hot water and central heating sides are checked before installing the boiler, as water quality will affect the reliability of the system. Outlined below are those water quality parameters which need to be met in order for the system to operate efficiently for many years. Failure of a heat exchanger due to lime scale build-up on the heating surface, low pH or other imbalance IS NOT covered by the warranty.

To assure extended service life, it is recommended to test water quality prior to installation. Listed below are some guidelines.

CAUTION

Do not use petroleum-based cleaning or sealing compounds in the boiler system. Damage to elastomer seals and gaskets in the system could occur, resulting in substantial property damage.

- **Water pH between 6.5 and 8.5**
 - Maintain water pH between 6.5 and 8.5. pH levels below 6.5 can cause an increase in the rate of corrosion. pH of 8.5 or higher can potentially cause lime scale build-up
- **Hardness less than 7 grains (120 mg/L)**
 - Hardness levels above the required amounts can lead to lime scale build-up throughout the system. Water below 5 grains/gallon (85 mg/L) may be over softened.
- **Chloride concentration less than 100 ppm (mg/L)**
 - Do not fill appliance or operate with water containing chlorides in excess of 100 ppm (mg/L).
- **Total Dissolved Solids (TDS) less than 500 ppm (mg/L)**
 - If using softened water to fill the appliance, it is still possible to have high TDS. This water can be corrosive. Consult local water treatment companies for other treatment solutions to reduce this affect.

Clean system to remove sediment*

1. You must thoroughly flush the system (without boiler connected) to remove sediment. The high-efficiency heat exchanger can be damaged by buildup or corrosion due to sediment.
2. For zoned systems, flush each zone separately through a purge valve. (If purge valves and isolation valves are not already installed, install them to properly clean the system.)
3. Flush system until water runs clean and you are sure piping is free of sediment.

*NOTE: It is recommended you clean heat exchanger at least once a year to prevent lime scale buildup. Follow the maintenance procedure to clean the heat exchanger in the Maintenance Section of this manual.

Test/replace freeze protection fluid

1. For systems using freeze protection fluids, follow fluid manufacturer's instructions to verify inhibitor level and that other fluid characteristics are satisfactory.
2. Freeze protection fluid must be replaced periodically due to

degradation of inhibitors over time. Follow all fluid manufacturer instructions.

NOTE: Boiler failure due to improper water chemistry is not covered by warranty.

B. Check for Gas Leaks

WARNING

Before starting the boiler, and during initial operation, smell near the floor and around the boiler for gas odorant or any unusual odor. Remove boiler front door and smell interior of boiler enclosure. Do not proceed with startup if there is any indication of a gas leak. Repair any leaks at once.

PROPANE BOILERS ONLY – The propane supplier mixes an odorant with the propane to make its presence detectable. In some instances the odorant can fade, and the gas may no longer have an odor. Before startup (and periodically thereafter), have the propane supplier verify the correct odorant level in the gas.

C. Freeze Protection (When Used)

WARNING

NEVER use automotive or standard glycol antifreeze. Do not use ethylene glycol made for hydronic systems. Use only freeze-protection fluids certified by fluid manufacturer as suitable for use with stainless steel boilers, verified in the fluid manufacturer's literature. Thoroughly clean and flush any system that has used glycol before installing the new boiler. Provide the boiler owner with a material safety data sheet (MSDS) on the fluid used.

1. Determine the freeze protection fluid quantity using total system water content following the fluid manufacturer's instructions. Remember to include expansion tank water content.
2. Local codes may require back flow preventer or actual disconnect from city water supply.
3. When using freeze protection fluid with automatic fill, install a water meter to monitor water makeup. Freeze protection fluid may leak before the water begins to leak, causing concentration to drop, reducing the freeze protection level.

D. Condensate Removal

1. The boiler is a high efficiency condensing boiler. Therefore, the unit has a condensate drain. Condensate fluid is nothing more than water vapor, derived from combustion products, similar to that produced by an automobile when it is initially started.

Condensation is slightly acidic (typically with a pH of 3 to 5) and must be piped with the correct materials. Never pipe the condensate using steel, copper, brass or other materials that will be subject to corrosion. Plastic PVC or CPVC pipe are the only approved materials.

A condensate neutralizer, if required by local authorities, can be made up of lime crystals, marble or phosphate chips that will neutralize the condensate. This may be done by the installer or you may purchase a condensate neutralizer from HTP (7350P-611).

2. The boiler is equipped with a ¾ female socket weld fitting connection that must be piped to a local drain. It is very important that the condensate line is sloped downward away from the boiler to a suitable inside drain. If the condensate outlet on the appliance is lower than the drain, you must use a condensate removal pump, available from HTP (554200). This pump is equipped with two leads that can be connected to an alarm or another type of warning device to alert the user of a condensate overflow, which, if not corrected, could cause property damage.

3. If a long horizontal run is used, it may be necessary to create a vent in the horizontal run to prevent a vacuum lock in the condensate line.

4. Do not expose the condensate to freezing temperatures.

5. It is very important you support the condensation line to assure proper drainage.

E. Fill and Test Water System

WARNING

Ensure the boiler is full of water before firing the burner. Failure to do so will damage the boiler. Such damage IS NOT covered by warranty, and could result in property damage, severe personal injury, or death.

1. Fill the system only after ensuring water chemistry meets the requirements listed in this manual.
2. Close the manual and automatic air vents and boiler drain valve.
3. Fill to the correct system pressure. Correct pressure will vary with each application.
 - a. Typical cold water fill pressure for a residential system is 12 psi.
 - b. Pressure will rise when boiler is turned on and system water temperature increases. Operating pressure must never exceed the relief valve pressure setting.
4. At initial fill and during boiler startup and testing, check system thoroughly for leaks. Repair all leaks before proceeding further.

CAUTION

Eliminate all system leaks. Continual fresh make-up water will reduce boiler life. Minerals can build up in the heat exchanger, reducing heat transfer, overheating the heat exchanger and causing heat exchanger failure.

5. The system may have residual substances that could affect water chemistry. After the system has been filled and leak tested, verify that water pH and chloride concentrations are acceptable by sample testing.

CAUTION

It is important to purge the system of air to avoid damage to the boiler.

F. Purge Air from Water System

Purge air from the system:

- a. Connect a hose to the purge valve and route hose to an area where water can drain and be seen.
- b. Close the boiler or system isolation valve between the purge valve and fill connection to the system.
- c. Close zone isolation valves.
- d. Open quick-fill valve on cold water make-up line.
- e. Open purge valve.
- f. Open the isolation valves one zone at a time. Allow water to run through the zone, pushing out the air. Run water until no noticeable air flow is present. Close the zone isolation valves and proceed with the next zone. Follow this procedure until all zones are purged.
- g. Close the quick-fill water valve and purge valve and remove the hose. Open all isolation valves. Watch the system pressure rise to correct cold-fill pressure. It is recommended that you put the pumps into manual operation to assist in purging the circuits.
- h. Disconnect the wires that are connected to the THERMOSTAT terminals of the customer connection board. Apply power to the boiler. The display will show the temperature of the water in the boiler. Press the **v** and **ENTER** keys simultaneously and hold for 1 second. The display will read:

```
SERVICE PUMP CH
PUMP ON          11:47A
```

The central heating pump will come on. If you then press the **^** key, the central heating pump will shut off. The display will read:

```
SERVICE PUMP OH
PUMP ON          11:47A
```

The DHW pump will come on. If the boiler is set up as a cascade master and you then press the **^** key again, the DHW pump will shut off. The display will read:

```
SERVICE PUMP SH
PUMP ON          11:47A
```

The system pump will come on. Use the **^** and **v** keys to toggle between running each pump in the system as required to help bleed out all entrapped air. Some good indicators that air is removed include the absence of gurgling noises in the pipes and pump operation becoming very quiet. Pressing **^** and **v** together at any time will return the boiler to normal operation.

- i. After the system has operated for five minutes, eliminate any residual air by using the manual air vents located throughout the system.
- j. If purge valves are not installed in the system, open manual air vents in the system one at a time, beginning with the lowest floor. Close vent when water squirts out. Repeat with remaining vents.
- k. Refill to correct pressure.

G. Check Thermostat Circuit(s)

1. Disconnect the two external wires connected to the boiler thermostat terminals (low voltage terminal strip).
2. Connect a voltmeter across these two incoming wires with power supplied to the thermostat circuits. Close each thermostat, zone valve and relay in the external circuit one at a time and check the voltmeter reading across the incoming wires.
3. There should NEVER be a voltage reading.
4. If a voltage reading does occur under any condition, check and correct the external wiring. (This is a common problem when using 3-wire zone valves.)
5. Once the external thermostat circuit wiring is checked and corrected if necessary, reconnect the external thermostat circuit wires to the boiler low voltage terminal strip. Allow the boiler to cycle.

H. Condensate Removal

1. The boiler is a high efficiency condensing boiler. Therefore, the unit has a condensate drain. Condensate fluid is nothing more than water vapor, derived from combustion products, similar to that produced by an automobile when it is initially started. Condensation is slightly acidic (typically with a pH of 3 to 5) and must be piped with the correct materials. Never pipe the condensate using steel, copper, brass or other materials that will be subject to corrosion. Plastic PVC or CPVC pipe are the only approved materials. A condensate neutralizer, if required by local authorities, can be made up of lime crystals, marble or phosphate chips that will neutralize the condensate. This may be done by the installer or you may purchase a condensate neutralizer from HTP (7350P-611).
2. The boiler is equipped with a $\frac{3}{4}$ female socket weld fitting connection that must be piped to a local drain. It is very important that the condensate line is sloped downward away from the boiler to a suitable inside drain. If the condensate outlet on the appliance is lower than the drain, you must use a condensate removal pump, available from HTP (554200). This pump is equipped with two leads that can be connected to an alarm or another type of warning device to alert the user of a condensate overflow, which, if not corrected, could cause property damage.
3. If a long horizontal run is used, it may be necessary to create a vent in the horizontal run to prevent a vacuum lock in the condensate line.
4. Do not expose the condensate to freezing temperatures.
5. It is very important you support the condensation line to assure proper drainage.

I. Final Checks Before Starting Boiler

1. Read Startup Procedures within this manual for proper steps to start boiler. (See Startup Report to record steps for future reference.)
2. Verify the boiler and system are full of water and all system components are correctly set for operation.

▲ WARNING

Ensure the boiler is full of water before firing the burner. Failure to do so will damage the boiler. Such damage IS NOT covered by warranty, and could result in property damage, severe personal injury, or death.

3. Fill condensate trap with water.
4. Verify electrical connections are correct and securely attached.
5. Inspect exhaust vent and intake piping for signs of deterioration from corrosion, physical damage or sagging. Verify exhaust vent and intake piping are intact and correctly installed per Venting Section and local codes.
6. Ensure both boiler power switches are activated before running the unit.

J. Cascade System - 1000 and 1700 Models

This boiler assembly is shipped factory preset to operate as a common vented cascaded unit. If the boiler is meant to be used as a common vented cascaded unit and additional boilers are not to be added to the system, skip this section.

Programming the Master Boiler:

- a. Pick one of the bottom boilers to be the Master Boiler.
- b. Make sure there is no demand for heat being supplied to the boiler.
- c. Apply power to the Master Boiler.
- d. Enter the system setting program navigation following instructions in Part 10 of this manual.
- e. Verify that cascade address function 15 is set to 0. This makes the master boiler address 0. NOTE: The Master Boiler MUST be addressed as 0. This establishes the unit as the master in a cascaded system.
- f. Change Function 23 to the total number of boilers in the system (4 BOILERS for a four boiler system, 6 BOILERS for a six boiler system, etc.)
- g. Exit the installer menu.

NOTE: The temperature set point of the master MUST match the follower boiler set point in order for the system to operate properly.

Additional Connected 1000 and 1700 Follower Boilers:

NOTE: READ THE NOTES BELOW BEFORE PROGRAMMING FOLLOWER BOILERS

- If one of the follower boilers has an indirect fired water heater connected directly to it, the address of this boiler must be 2 or greater.
- It is recommended but not necessary to address boilers in the order that they are wired.
- No two boilers can have the same address.
- Maximum amount of boilers in a cascaded system is eight (8), equal to four (4) double-stacked units.
 - a. Make sure there is no demand for heat being supplied to the master boiler
 - b. Apply power to the follower boiler you are working on.
 - c. Enter system settings following instructions in Part 10 of this manual
 - d. Set cascade address parameter 15 to 1 for the first follower, 2 for the second follower, etc. depending which boiler you are programming based on the above notes. This establishes the boiler as a follower in a cascaded system and enables data to be transferred as needed for the system to function at full capability.

NOTE: DO NOT select number 8.

NOTE: The top boiler in a 1000 or 1700 assembly is factory preset to 1.
 - e. Change "CASCADE MODE" Function 23 to COMMON FLUE on all boilers EXCEPT the Master Boiler. This is the default setting on the top boiler in a 1000 or 1700 unit.
 - f. Exit the installer menu.

NOTE: The temperature set point of the follower must match the master boiler set point in order for the system to operate properly.

Part 10 - Start-Up Procedure

▲ WARNING

FOR YOUR OWN SAFETY READ BEFORE OPERATING

1. This boiler does not have a pilot. It is equipped with an ignition device which automatically lights the burner. Do not try to light the burner by hand.
2. BEFORE OPERATING: Smell all around the boiler area for gas. Be sure to smell next to the floor because some gas is heavier than air and will settle on the floor.

3. WHAT TO DO IF YOU SMELL GAS

- Do not try to light any boiler.
 - Do not touch any electric switch, do not use any phone in your building.
 - Immediately call your gas supplier from a neighbor's phone. Follow the gas suppliers' instructions.
 - If you cannot reach your gas supplier, call the fire department.
 - Turn off the gas shutoff valve (located outside the boiler) so that the handle is crosswise to the gas pipe. If the handle will not turn by hand, don't try to force or repair it, call a qualified service technician. Force or attempted repair may result in a fire or explosion.
4. Do not use this boiler if any part has been under water. Immediately call a qualified service technician to inspect the boiler and to replace any part of the control system and any gas control that has been damaged.
 5. The boiler shall be installed so the gas ignition system components are protected from water (dripping, spraying, rain, etc.) during boiler operation and service (circulator replacement, condensate trap, control replacement, etc.)

Failure to follow these instructions could result in property damage, serious personal injury, or death.

If you discover any evidence of a gas leak, shut down the boiler at once. Find the leak source with a bubble test and repair immediately. Do not start the boiler again until the leak is repaired. Failure to comply could result in substantial property damage, severe personal injury, or death.

A. Control Overview

The control is one of the primary safety devices of the boiler. It monitors the safety sensors of the boiler to assure safe and efficient operation.

The control has many features associated with system design. This section addresses programming features, including Boiler Settings / System Settings / Maintenance Settings and System Diagnostics, to help in customizing your control. It is important to fully understand control capabilities before customization, as its factory defaults may already fit your system design and not require any adjustment at all.

B. Navigation of the Display

The display includes a two line backlit LCD readout to provide informative messages about the operation of the boiler. Many operating parameters can be viewed and adjusted by using the six buttons on the display. The function of each button is described below.

RESET – The RESET button has two functions.

- Resets any lockout error code
- Returns the user to the default display screen.

ENTER – The ENTER key is used to access parameter programming mode. To access this mode, hold down the ENTER key for more than 4 seconds. The readout will change to:

ENTER MENU CODE 000

One of the zeroes will be blinking. Use the **^ v** arrow keys to change the blinking digit to the correct value. Use the **< >** arrow keys to select the next digit to change and again use the **^ v** keys to change the value. Repeat until the correct code is entered. Press the **ENTER** key to accept the code entered. If the code is correct, the readout will change to the appropriate screen. If the programming code is not accepted, the readout will continue to display as shown above.

ENTER is also used to enable a function for editing. After the user navigates to the desired function, the user holds down **ENTER** for one second. When **ENTER** is released, the function value will begin to blink. The function can now be changed using the **^ v** keys. After the new value is displayed, the user then presses **ENTER** for 1 second to lock the new value of the function. The value will then stop blinking.

LEFT AND RIGHT ARROW KEYS – **< >** are used to navigate between the default display, status display, analog and cascade displays if they are enabled. The **< >** keys are also used in programming modes to change between programmable functions. It is recommended you use the Menu Maps in the back of this manual and the detailed menu instructions printed in this section to help in menu navigation.

UP AND DOWN ARROW KEYS – **^ v** are used to navigate between the various functions displayed in the menu. After the function is enabled for editing by pushing the **ENTER** key, the **^ v** keys are used to adjust the function upward or downward to the desired value.

C. Operating Instructions

Before operating the unit, it is important to remove the cover and verify that the gas line and water lines are connected to boiler and fully purged. If you smell gas, STOP; Follow the safety instructions listed in the first part of this section. If you do not smell gas, follow the next steps.

1. Turn down the thermostats before applying power to the boiler. If 0–10 volt or other inputs are used, make sure that they are set so there is no call for heat while programming.
2. Turn on the power to the boiler or boilers if a cascade system used.
3. Next, check the boiler settings. Adjustment and factory defaults are outlined within this section. If a cascade system is used, it is important that all the boilers have the same boiler settings.
4. Next, check the system settings. Adjustments and factory defaults are outlined within this section. If a cascade system is used, it is important that the Master Boiler is programmed with the correct system settings.
5. Create a demand on the boiler or boilers if a cascade system is used. The user can monitor system functions when the boilers are operational.
6. If the boilers fail to start, refer to the troubleshooting section in the back of this manual.

D. Programming Boiler Settings

Boiler Setting Program Access

Note: Programming the boiler control is not possible when the boiler is firing. Make sure any input which can create a demand on the boiler, such as the tank thermostat, is turned off, so the boiler will remain idle to allow programming.

Screen	Description
ENTER MENU CODE 000	To access the boiler setting program, press and hold ENTER for 4 seconds until the display shows the screen at left.
ENTER MENU CODE 600	Use the arrow keys to log in the Boiler Menu Access Code - 600 . Press ENTER to confirm the code and access the Boiler Setting Program navigation menu.

Table 15 - Boiler Setting Access

Boiler Setting Program Navigation

Once the code is confirmed, the user can start to set the **Boiler Settings**. Use the arrow keys on the display to navigate through the **Boiler Settings**. A blinking setting indicates the setting can be changed. To change a setting, press **ENTER**. Boiler settings can be increased by pressing **^** and decreased by pressing **v** on the display. When done, press **ENTER**. The setting will stop blinking and the user can move on to next setting. Press **RESET** to exit programming and store settings. Listed below are the boiler settings that can be programmed into the control.

Screen	Description
CENTRAL HEAT 180 °F	Allows the user to adjust the boiler set point from 50°F to 190°F (Factory Default 180°F).
CENTRAL DIFF SET 30 °F	Adjusts the boiler differential set point from 5°F to 30°F (Factory Default 30°F).
DHW SETPOINT 119 °F	Adjusts the indirect tank set point from 70°F to 185°F (Factory Default 119°F).
DHW DIFF SETPOINT 7 °F	Adjusts the DHW differential set point from 1°F to 30°F (Factory Default 7°F).
TEMP DISPLAY C OR F °F	Adjusts the temperature measurement in F = Fahrenheit to C = Celsius (Default is Fahrenheit).

Table 16 - Boiler Setting Program Navigation

Clock Settings

(NOTE: The clock will reset if the boiler is powered off for more than a week.)

Screen	Description
CLOCK MODE (12/24) 08/28/2009 Fr 9:42A	Changes the clock from 12 hour mode (8:45 PM) to 24 hour mode (20:45). To change to 24 hour mode, press ENTER . The letter (A or P) after the time will blink. Press the up or down arrow key once and the letter will disappear. Press ENTER to save the new setting.
CLOCK HOUR 08/28/2009 Fr 10:01A	Allows the user to adjust the hour setting.
CLOCK MINUTE 08/28/2009 Fr 10:01A	Adjusts the minute setting.
CLOCK DAY OF WEEK 08/28/2009 Fr 10:01A	Adjusts the day of the week.
CLOCK DATE MODE 08/28/2009 Fr 10:01A	Allows the user to switch to European date format (2009/08/28) from US format (08/28/2009).
CLOCK YEAR 08/28/2009 Fr 10:01A	Adjusts the year setting.
CLOCK MONTH 08/28/2009 Fr 10:01A	Adjusts the month setting.
CLOCK DATE 08/28/2009 Fr 10:01A	The clock is set.

Table 17 - Clock Setting Screens

(NOTE: The internal clock does not adjust for daylight savings time and requires manual adjustment.)

E. Programming the System Setting

System Setting Program Access

Note: Programming the boiler control is not possible when the boiler is firing. Make sure any input which can create a demand on the boiler, such as the tank thermostat, is turned off, so the boiler will remain idle to allow programming.

Screen	Description
ENTER MENU CODE 000	To access the boiler setting program, press and hold ENTER for 4 seconds until the display shows the screen at left.
ENTER MENU CODE 925	Use the arrow keys to log in the Boiler Menu Access Code - 925 . Press ENTER to confirm the code and access the Boiler Setting Program navigation menu.

Table 18 - System Setting Access

F. System Setting Program Navigation

Once the **System Menu Access Code** is confirmed, the user can begin to set the system setting menu. Use the < > keys on the display to navigate through the System Settings. To change a setting, press **ENTER**. System settings can be **increased** by pressing **^** and **decreased** by pressing **v** on the display. When done, press **ENTER**. The setting will stop blinking and you can move on to next setting. Press **RESET** to exit programming and store settings. Listed below are the boiler settings that can be programmed into the control.

Screen	Description
Function 1	Factory Program Mode
MODE INDIRECT 1	This indicates that the control is configured correctly. Do not change this setting.
Function 3	DHW Tank Max Temp
DHW TANK MAX TEMP 180 °F 3	This is the maximum temperature that can be selected in boiler settings for the DHW tank. Factory Default is 180°F. (Range: 95°F to 180°F)
Function 6	DHW Post Pump Time
DHW POST PUMP TIME 0 MINUTES 6	The indirect pump has the ability to post purge energy from the boiler to run the pump after the set point has been achieved. Please note that running the pump for a time greater than 5 minutes may cause tank energy to be released back to the heat exchanger. Factory Default of 0 Minutes. (Range: 0 – 10 minutes)
Function 7	Warm Weather Shutoff
WARM WEATHER OFF 68 °F 7	When used with an outdoor sensor, warm weather shut down will disable the boiler if the programmed outdoor temperature is exceeded. Default: 68°F (Range: 41°F to 122°F).
Function 8	Min Outdoor Temp
MIN OUTDOOR TEMP 5 °F 8	Sets the minimum outdoor design temperature for the system. Default: 5°F (Range: -49°F to 32°F).

Screen	Description
Function 9	Max Supply Temp
MAX SUPPLY TEMP 190 °F 9	Sets the maximum design supply temperature based on the minimum outdoor design temperature. Default: 190°F (Range: 77°F to 190°F).
Function 10	Max Outdoor Temp
MAX OUTDOOR TEMP 68 °F 10	Sets the maximum outdoor design temperature for the system design. Default: 68°F (Range 32°F to 190°F).
Function 11	Min Supply Temp
MIN SUPPLY TEMP 95 °F 11	Sets the design supply water temperature based on the maximum outdoor design temperature. Default: 95°F (Range: 32°F to 190°F).
Function 12	Min Boiler Temp
MIN BOILER TEMP 68 °F 12	Sets the design minimum heat curve temperature for central heat. Default: 68°F (Range: 32°F to 190°F).
Function 13	CH Post Pump Time
CH POST PUMP TIME 0 MINUTES 13	Allows the user to set the boiler pump post purge time once the thermostat is satisfied. Default: 0 minutes (Range: 0 – 10 minutes).
Function 14	DHW Priority
DHW PRIORITY 30 MINUTES 14	Allows the user to set the maximum run time for the indirect fired water heater and the minimum run time for central heating. Default: 30 minutes (Range: 0 – 60 minutes).
Function 15	Cascade Address
CASCADE ADDRESS 0 15	Bus addressing boilers (maximum boilers allowed 8 in a cascade system). Master Boiler address is 0 and Following Boilers are addressed 1 thru 7. Default: 0 (Range: 0 – 8). NOTE: DO NOT USE ADDRESS 8.
Function 16	Optional Inputs
OPTIONAL INPUT RETURN SEN 16	Allows the user to select optional inputs to control or monitor the system. Default: RETURN (Range: Off / Booster Board / 0-10 Volt / DHW Sensor / Return Sen).
Function 17	0-10 Volt Function
0-10 VOLT FUNCTION TEMPERATURE 17	Control boiler modulation through temperature control. Factory Default = Temperature (Range: Temperature or Fan Speed).
Function 18	Step Modulation Mode
STEP MODULATE MODE ON 18	Allows the user to turn ON the step modulation, which regulates burner output in six steps at one minute intervals. Step modulation will start at the last modulation rate of the boiler and work up one minute at a time. Default: OFF (Selection: OFF or ON).

Function 19	Boiler DHW Temp	Screen	Description
BOILER SUPPLY DHW 180 °F	19 Allows the user to program the boiler supply water temperature to the indirect heat exchanger during a demand cycle. Default: 180°F (Range: 119°F to 190°F).	Function 26	System Freeze Protection
Function 20	Water Safety Input	SYS FREEZE PROT PROTECT OFF	26 NOTE: This parameter is only present if the boiler is a cascade master. Allows the user to set the freeze protection when a system pump is used. Factory Default: OFF. Selection of temperature activates freeze protection. (Range: OFF, -40°F – 104°F).
WATER SAFETY INPUT WATER PRESSURE	20 The user can select various water safety inputs used in the boiler system. Default: Flow Switch (Range: None / Low Water Cut Off / Flow Switch / Water Pressure).	Function 27	Error System Sensor
Function 21	Error Outdoor Sensor	ERROR SYSTEM SENS ON	27 Sets the control to display an error message if the system sensor is open or shorted. NOTE: This error does not stop the boiler (or boilers) from running. Factory Default: ON (Range: ON / OFF).
ERROR OUTD SENSOR OFF	21 Allows the user to set the control to display an error message if an outdoor sensor is open or shorted. NOTE: This error does not stop the boiler from running. Factory Default: OFF (Range: ON / OFF / PHOEN ON).	Function 28	Freeze Protection
Function 22	Adjust Boiler Output %	FREEZE PROTECTION ON	28 Allows the user to set freeze protection on the boiler. Factory Default: ON (Range: ON / OFF).
ADJ BOILER OUTPUT 100%	22 Adjusts the boiler output down from 100% to 50%. Factory Default: 100%. (Range: 100% – 50%)	Function 29	DHW Modulation Mode
Function 23	Cascade Mode	DHW MODULATE MODE NORMAL MOD	29 This parameter controls how the boiler modulates for a DHW demand. In NORMAL MOD mode, the boiler will modulate down from high fire when there is a DHW demand. In LOW MOD mode, the boiler will modulate up from low fire when there is a DHW demand. This mode is useful to minimize short cycling when a large boiler and small indirect tank are used together. Factory Default: NORMAL MOD (Range: NORMAL MOD / LOW MOD).
Top Boiler	23 Allows the user to select the cascade mode. If one or more 1000 or 1700 units are cascaded in a common vent manifold, select the number of individual cascaded boilers in the system on the cascade master (2 BOILERS if a single MOD CON 1700, 6 BOILERS if three MOD CON 1000s, etc.) On cascade followers in a common vent system, select COMMON FLUE to establish a cascaded system WITH common vent. Factory Default: 2 BOILERS on Cascade Master (bottom boiler), COMMON FLUE on Cascade Follower (top boiler). Range: ALL 926 / 2 – 8 BOILERS [on cascade master ONLY] / COMMON FLUE [on cascade followers ONLY]). NOTE: All MOD CON 1000 and 1700 boilers are to be configured as COMMON VENT systems.	Function 30	Extra Boiler Mode
CASCADE MODE COMMON FLUE		EXTRA BOILER MODE OFF	30 Allows for a non HTP boiler to be controlled when the cascade output has risen above the percent of the cascade firing rate set in this parameter. Factory Default: Off (Range: 50% - 100%).
Bottom Boiler	CASCADE MODE 2 BOILER	Function 31	System Sensor Mode
Function 24	Cascade Rotation	SYSTEM SENSOR MODE OFF	31 Suppresses the 'NO FOLLOWER' display message if the boiler is used as a cascade master boiler with no follower boilers connected. Factory Default: OFF (Range: ON / OFF).
CASCADE ROTATION 48 HOURS	24 Sets the amount of hours before the first boiler in the cascade firing rotation will be changed. NOTE: If this is set to 0, the firing order of the boilers will not rotate. Default: 48 hours (Range: 0 – 240 hours).	Function 32	Service Schedule
Function 25	Cascade DHW Mode	SERVICE SCHEDULE OFF	32 Selects a service date or time based on the boiler run hours to program the boiler maintenance schedule. Factory Default: OFF (Range: Date or Run Hours). NOTE: Without setting this function, Functions 33/34/35/36 will not display.
NOT USED NOT USED	25 Not applicable on this product.		

Function 37	Modbus Mode
MODBUS MODE OFF 37	Enables Modbus Mode on the appliance. Factory Default: OFF (Range: OFF, ON, AUTO). NOTE: Turning Modbus Mode "ON" will open a number of additional parameters to customize Modbus installation. See Modbus Instructions (lp-372) for details. NOTE: Turning this Mode "ON" without a connected and powered Modbus communication adapter (p/n 7350P-629) will result in improper appliance operation. Service calls associated with this ARE NOT covered by warranty.

Table 19 - System Setting Program Navigation

NOTE: For the following functions, you must have your maintenance function turned on.

To change these functions, press **ENTER**. The left most digit will begin to blink. Use the **^** or **v** arrows to change the digit. Use the **<** **>** arrow keys to switch between digits. When you've made your selection, press **ENTER** again.

Screen	Description
Function 33	Year
SERVICE SCHEDULE YEAR 00/00/2000 33	Allows the user to set the year of the next service reminder.
	Hours
SERVICE SCHEDULE 10000's 000000 33	Allows the user to set the left two digits of the amount of run hours before next service reminder.
Function 34	Month
SERVICE SCHEDULE MONTH 00/00/2000 34	If the date function was selected, this function programs the month. If you selected the run hour function, you will need to program 10,000 hours, if required.
	Hours
SERVICE SCHEDULE 10000's 000000 34	Allows the user to set the middle two digits of the amount of run hours before next service reminder.
Function 35	Day
SERVICE SCHEDULE DAY 00/00/2000 35	Sets the day of next service reminder.
	Hours
SERVICE SCHEDULE 10000's 000000 35	Sets the two right digits of the amount of run hours for the next service reminder.
Function 36	Telephone
TELEPHONE # 000 000 0000 36	Allows the user to input a telephone number that will display when maintenance is required.

Table 20 - Maintenance Reminder Function Screens

G. Resetting the Maintenance Schedule

When the system control flashes MAINTENANCE REQUIRED, it is advisable that you call for service. After the service is performed, reset the schedule for the next required service by using the following steps. Press **ENTER** on the display for 3 seconds. The Menu code will appear as 000. This does not change. Press **ENTER** again. SERVICE SCHEDULE

RESET will be displayed. Using the **>** key scroll to the selection of year or hours. Press **ENTER** to reset the selected Service Schedule. To change a setting, press **ENTER**. Press the **^** and **v** keys to make adjustments. Press **ENTER** when reset is complete.

Part 11 - Start-Up Procedures for the Installer

A. Boiler Control Status Menu

The boiler control also has the ability to review system status. To access the status screens, press **>**. Once the first value is displayed, press **^** and **v** to scroll through additional information. At any point press **RESET** to exit the status screens.

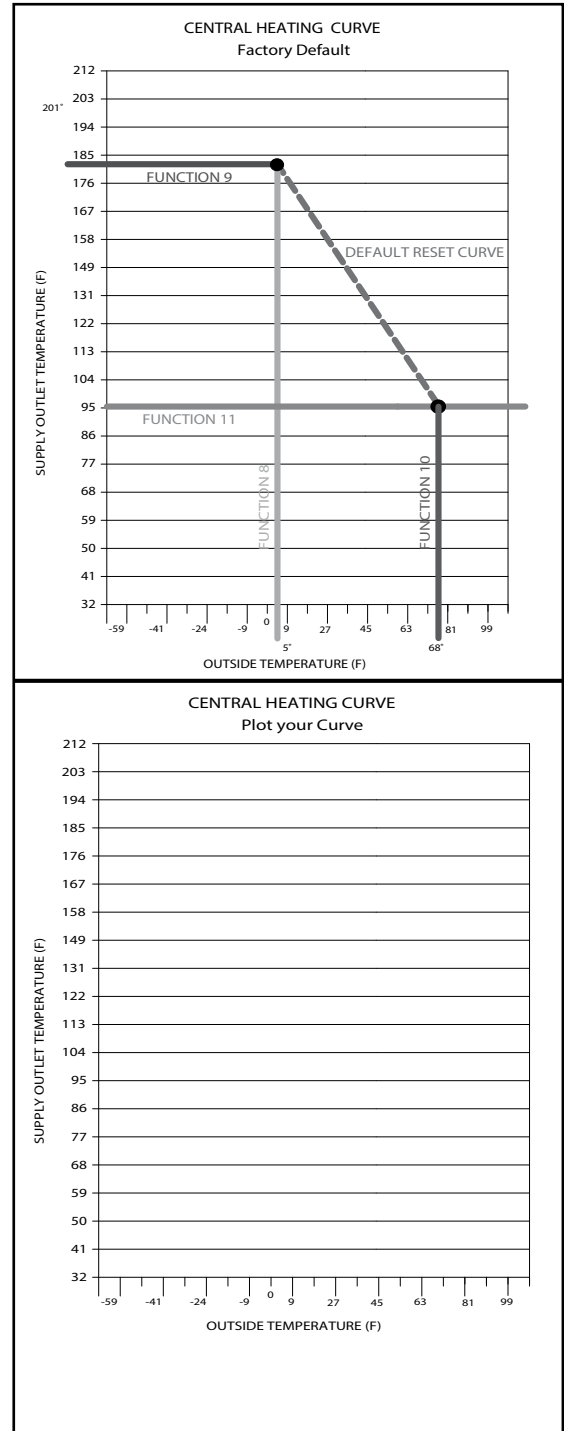

Table 21 - Heating Curve - NOTE: The user can adjust the heat curve down by lowering the central heating temperature.

Screen	Description
SUPPLY SEN 180°F RETURN SEN 150°F	This is the first screen that appears after pressing >, and shows the actual temperatures measured by the supply and return sensors. NOTE: If the boiler is configured to use a 0 – 10 volt input, the return sensor is disabled and the second line of the display will be blank.
Press v once.	
CH SET 180°F SUPPLY SEN 122°F	The screen displays the current central heating temperature set point on the top line. NOTE: This temperature set point may vary from what was set in the boiler settings if an outdoor sensor is used. The actual temperature measured by the supply sensor is displayed on the bottom line.
Press v once.	
CH DEMAND BOILER OFF	This screen displays the central heat demand set for the cascade system.
Press v once.	
0-10 SNGL ON *	Shows if 0-10 volt is enabled.
Press v once.	This screen appears only when the boiler is set as a Master Boiler.
CAS SET 190°F SYSTEM 112°F	This screen displays the cascade set point (maximum 190°F) on the top line. The system sensor reading is on the second line. The control will cascade the boilers up to this set point depending on demand.
Press v once.	
DHW SET 119°F DHW 117°F	Displays the current tank temperature set point on the top line. The actual temperature measured by the tank or return sensor (HTP 7250P-325) is displayed on the bottom line. If a mechanical aquastat is used in place of the recommended sensor, the second line will display 'OFF' in place of the temperature if the aquastat measures close to its set temperature, or 'ON' if the aquastat temperature is too low.
Press v once.	
OUTDOOR FLUE 11°F 95°F	The current outdoor temperature is displayed on the top line. If there is no outdoor sensor connected to the boiler, this line will display "OFF" in place of the temperature. If the outdoor sensor is shorted, this line will display "ON" in place of the temperature. The second line displays the current boiler flue temperature.
Press v once.	

FLAME 0.0uA FAN SPEED 3497 RPM	This screen displays boiler flame current on the top line. The second line displays boiler fan speed.
Press v once.	
0-10 V * 0.0V	The top line displays the voltage on the optional input. This voltage is only relevant if an external 0-10 volt signal is being used to control the boiler.
Press v once.	
BUS COMM NO CONN	This display shows the status of the communication bus between multiple boilers. If in a single boiler configuration, the display will show 'NO CONN'. In a multiple boiler configuration, if this is the Master Boiler and other boilers are connected to the communication bus and powered, this screen will show the address of each boiler connected to the bus.
Press v once.	
POWER ON 0H CH ON 0H	The top line indicates the amount of hours the boiler has been powered over its life. The second line indicates how many hours the burner has been on for central heat demand over its life.
Press v once.	
DHW ON 0H GOOD IGNIT 1X	The top line indicates the hours the burner has been on for hot water demand over the boiler's life. The second line indicates how many times the burner has successfully ignited over the boiler's life.
Press v once.	
SYS CH ON 0H SYS DHW ON 0H	This screen displays how many hours the boiler has run to meet central heat and DHW demand.

Table 22 - Boiler Control Status Menu Screens

The next ten screens display the last ten boiler lockout faults. Press v to scroll through the faults from most recent to oldest.

Screen	Description
FAULT HISTORY 1 07/27/2009 Mo 5:19A	This screen displays the most recent boiler control lockout fault. The top line will alternate between the words 'FAULT HISTORY' and the fault code encountered. The bottom line displays the date and time the fault occurred.
Press v once.	
FAULT HISTORY 2 08/28/2009 Fr 5:19A	This screen displays the second oldest boiler control lockout fault. The top line will alternate between the words 'FAULT HISTORY' and the actual fault encountered. The bottom line will display the date and time that the fault occurred.
Press v once.	

FAULT HISTORY 3 08/28/2009 Fr 5:19A	This screen displays the third oldest boiler control lockout fault. The top line will alternate between the words 'FAULT HISTORY' and the actual fault encountered. The bottom line will display the date and time that the fault occurred.
Press v once.	
FAULT HISTORY 4 08/28/2009 Fr 5:19A	This screen displays the fourth oldest boiler control lockout fault. The top line will alternate between the words 'FAULT HISTORY' and the actual fault encountered. The bottom line will display the date and time that the fault occurred.
Press v once.	
FAULT HISTORY 5 08/28/2009 Fr 5:19A	This screen displays the fifth oldest boiler control lockout fault. The top line will alternate between the words 'FAULT HISTORY' and the actual fault encountered. The bottom line will display the date and time that the fault occurred.
Press v once.	
FAULT HISTORY 6 08/28/2009 Fr 5:19A	This screen displays the sixth oldest boiler control lockout fault. The top line will alternate between the words 'FAULT HISTORY' and the actual fault encountered. The bottom line will display the date and time that the fault occurred.
Press v once.	
FAULT HISTORY 7 08/28/2009 Fr 5:19A	This screen displays the seventh oldest boiler control lockout fault. The top line will alternate between the words 'FAULT HISTORY' and the actual fault encountered. The bottom line will display the date and time that the fault occurred.
Press v once.	
FAULT HISTORY 8 08/28/2009 Fr 5:19A	This screen displays the eighth oldest boiler control lockout fault. The top line will alternate between the words 'FAULT HISTORY' and the actual fault encountered. The bottom line will display the date and time that the fault occurred.
Press v once.	
FAULT HISTORY 9 08/28/2009 Fr 5:19A	This screen displays the ninth oldest boiler control lockout fault. The top line will alternate between the words 'FAULT HISTORY' and the actual fault encountered. The bottom line will display the date and time that the fault occurred.
Press v once.	

FAULT HISTORY 10 08/28/2009 Fr 5:19A	This screen displays the tenth oldest boiler control lockout fault. The top line will alternate between the words 'FAULT HISTORY' and the actual fault encountered. The bottom line will display the date and time that the fault occurred.
---	---

Table 23 - Boiler Fault Screens

B. Cascade Menu

This menu is accessed by pressing < at the default menu or > at the status menu of the Master Boiler.

Screen	Description
CASCADE MASTER READY SYS PUMP OFF	This screen displays when the boiler is configured as a Cascade Master and the system is ready to accept a demand for heat. The second line indicates the cascade system pump output status. This screen alternates with the default screen every 5 seconds or can be accessed by pressing the < key from the default screen.
CASCADE NO FOLLOWER SYS PUMP OFF	This screen displays when the boiler is configured as a Master Boiler and there are no connected follower boilers, or the follower boilers are not powered. The second line indicates cascade system pump output status. This screen alternates with the default screen every 5 seconds or can be accessed by pressing the < key from the default screen.
CASCADE NO SENSOR SYS PUMP OFF	This screen displays when the boiler is configured as a Master Boiler and there is no system temperature sensor connected or the system sensor is defective. The cascade system will still function in this situation with reduced efficiency. All boilers will run simultaneously rather than in a staged fashion. The second line indicates cascade system pump output status. This screen will alternate with the default screen every 5 seconds or can be accessed by pressing the < key from the default screen.
CASCADE TT 0123 567 SYS PUMP ON 12:47P	This screen displays information about cascade status. The TT in the center of the top line shows that cascade demand is coming from TT contact being closed. You may also see DHW if the demand is from a DHW sensor, or 0-10 if the demand is from a 0-10 volt input. The following numbers show which boiler addresses are currently communicating to the master. If a boiler address is not used or communicating, the number will not display. In the example to the left, boiler address #4 is not communicating. When a boiler in the system is firing, its address number will alternate with a " to signify it is firing. The bottom line shows the status of the system pump output contacts.
Press v once.	

CASCADE PWR 100% PRESENT 01234567	This screen displays overall cascade power output. The range of this value is the number of boilers communicating with the Master x 100. For example, if 8 boilers are connected and firing, the maximum cascade power is 800%. The second line shows which boiler addresses are communicating with the Master.
Press v once.	
CASCADE SYST 118°F CASCADE SET 190°F	This screen displays current system temperature sensor reading on the top line and the cascade system temperature setting on the bottom.
Press v once.	
BOILER 0 100% BOILER 1 56%	This screen displays the current cascade power demand output on a per connected boiler basis for boilers addressed as 0 and 1. In the example, boiler 0 is being commanded to fire at 100% and boiler 1 at 56%. If this were a 2 boiler system, the 'CASCADE PWR' screen above would read 156%.
Press v once.	
BOILER 2 0% BOILER 3 0%	This screen displays the current cascade power demand output on a per connected boiler basis for boilers addressed as 2 and 3.
Press v once.	
BOILER 4 0% BOILER 5 0%	This screen displays the current cascade power demand output on a per connected boiler basis for boilers addressed as 4 and 5.
Press v once.	
BOILER 6 0% BOILER 7 0%	This screen displays the current cascade power demand output on a per connected boiler basis for boilers addressed as 6 and 7.

Table 26 - Cascade Menu

C. Boiler Test Mode

This function is intended to simplify gas adjustment. The following tables include recommended combustion settings by fuel type and boiler fan speeds. Automatic modulation does not take place while the controller is in Test Mode. However, the boilers will modulate down if the program set point is reached while running in Test Mode. It is recommended to enter Test Mode with the largest load possible to create such a heat demand that Test Mode will not be interrupted. To enter Test Mode press **^** and **ENTER** simultaneously. **NOTE:** The boiler will automatically exit Test Mode after 20 minutes of operation.

To leave Test Mode press **^** and **v** simultaneously.

SERVICE RUN	3400 RPM
PUMP ON	4:49P

Combustion Settings on All Models						
Fan Speed	Natural Gas (NG)			Propane (LP)		
	Low	Ignition	High	Low	Ignition	High
Carbon Monoxide (CO) PPM	5-50	35-100	≤150	5-50	35-100	≤150
Carbon Dioxide (CO ₂) %	8-10	8 1/2-10 1/2		9-10 1/2	9 1/2-11	

Table 24 - Combustion Settings - All Models

Fan Speeds			
Model	Ignition	Min	Max
1000	3000	1950	7200
1700	3000	2200	6800

Table 25 - Fan Speeds

Part 12 - Troubleshooting

A. Boiler Error and Fault Codes

If any of the sensors detect an abnormal condition, or an internal component fails during the operation of the boiler, the display may show an error message and error code. This message and code may be the result of a temporary condition, in which case the display will revert to its normal readout when the condition is corrected, or it may be a condition that the controller has evaluated as not safe to restart the boiler. In this case, the boiler control will be locked out, the red FAULT light will be lit, and the message "LOCKOUT" will be displayed on the readout in the lower line.

The boiler will not start until a qualified technician has repaired the boiler and pressed the RESET button for more than 1 second. If there is an error message displayed on the readout, and the message "LOCKOUT" is not displayed and the FAULT light is not lit, then the message is the result of a temporary condition and will disappear when the problem corrects itself.

IMPORTANT NOTE: If you see error messages on your display readout, call a technician immediately, since the message may indicate a more serious problem will occur soon.

B. Boiler Error

The controller will display an error code and message when an error condition occurs. These error codes, descriptions, and recommended corrective actions are described in Section D.

C. Boiler Fault

1. The controller will illuminate the red "FAULT" indication light and display a fault code and message when a fault condition occurs. The alarm output will also activate. Most fault conditions cause the CH pump to run in an attempt to cool the boiler.
2. Note the displayed fault code and refer to Section D for an explanation of the message along with several suggestions for corrective actions.
3. Press **RESET** to clear the fault and resume operation. Be sure to observe the operation of the unit for a period of time to assure correct operation and no reoccurrence of fault message.

▲ WARNING

When servicing or replacing components that are in direct contact with boiler water, be certain that:

- There is no pressure in the boiler. (Pull the release on the relief valve. Do not depend on the pressure gauge reading.
- The boiler water is not hot.
- The electrical power is disconnected.
- The gas is shut off.

Failure to make these checks could result in substantial property damage, serious personal injury, or death.

If overheating occurs or the gas supply fails to shut off, do not turn off electrical power to the circulating pump. This may aggravate the problem and increase the likelihood of boiler damage. Instead, shut off the gas supply to the boiler at the gas service valve. Failure to do so may result in property damage, personal injury, or death.

▲ WARNING

DO NOT USE THIS APPLIANCE IF ANY PART HAS BEEN SUBMERGED IN WATER. Immediately call a qualified service technician. The appliance **MUST BE** replaced if it has been submerged. Attempting to operate an appliance that has been submerged could create numerous harmful conditions, such as a potential gas leakage causing a fire and/or explosion, or the release of mold, bacteria, or other harmful particulates into the air. Operating a previously submerged appliance could result in property damage, severe personal injury, or death.

NOTE: Appliance damage due to flood or submersion is considered an Act of God, and IS NOT covered under product warranty.

▲ CAUTION

Label all wires prior to disconnecting them when servicing the boiler. Wiring errors can cause improper and dangerous operation. Failure to follow these instructions may result in property damage or personal injury.

NOTE: If system return temperatures are maintained below the dew point, condensation will form on the inside of the boiler cabinet and cause some internal sheet metal components to rust.

D. User Interface Display
Cascade Control Fault Codes

Screen	Description	Possible Remedy
SYS SUPPLY SENSOR PUMP OFF E03	E03 indicates a problem with the system sensor circuit. The circuit could be open or shorted. Possible reasons for this error are: There is no system sensor connected to the Master Boiler. The system sensor is faulty. There is a short circuit in the system sensor wiring; possibly from a staple placed through the wire, or damage to the wire causing both conductors to touch. The system sensor wiring is open due to defect or damage.	Disconnect the system sensor from the wiring and measure it's resistance. Compare the measured resistance to the table in this manual to see if it corresponds to the temperature of the sensor. If the resistance does not agree with the sensor, replace the sensor. If the sensor is OK, disconnect the sensor wiring from both the boiler and the sensor and check continuity using an ohmmeter. Repair or replace as necessary. If this error is present, the boilers in the cascaded group will run and ignite simultaneously when there is a heat demand. Each boiler will modulate to maintain set point temperature on its own supply sensor. This code automatically resets when repair is complete. This code will not display if system setting function ERROR SYSTEM SENS is set to OFF.
TEMPER BLOCKING PUMP ON TT	TT indicates there is a demand for heat on the boiler, the pump is powered on, and the supply sensor temperature is too high for the boiler to ignite. This occurs because the water temperature measured by the supply sensor is higher than the tank temperature – ignition diff setting.	This message will stay present until the water temperature measured by the supply sensor is less than the tank temperature – ignition diff setting.
LOW WATER LEVEL PUMP OFF LEO	Water level in the boiler is low.	1. Check boiler feed water system to be sure it is supplying make-up water to the boiler system. 2. Be sure all air is bled from the system. 3. Check for leaks in the boiler and system piping and repair as necessary. 4. Inspect low level switch and wiring for damage and repair as necessary.
HIGH FLUE PRESS FLU PUMP ON	FLU indicates excessive flue pressure. This code resets automatically after the high pressure condition is resolved. The second line indicates pump status.	1. Assure the flue is not blocked. 2. Check the switch wiring by applying a jumper in place of the switch. If the code clears with the jumper in place, REPLACE the flue switch and connect the wires to the new switch BEFORE running boiler.
WARNING: Do not use jumper to remedy an FLU error. Faulty switch MUST be replaced. Failure to follow this instruction could result in serious personal injury or death.		

24 VOLT LOW LOU PUMP ON	LOU indicates the 24 volt power supply on the control is damaged or overloaded. This code resets automatically if it is the result of an overload and the overload condition is removed. The second line indicates the status of the pump. Note that while 24 volt power is low, the pump output will be on.	<ol style="list-style-type: none"> 1. Check line voltage. It must be between 100 and 128 volts. 2. If available, connect a PC and use HTP service software to check the 24v supply display in the lower left corner of the screen. The number displayed here must be greater than 128 and should be no greater than 250. Use this as a troubleshooting guide as you follow the steps below. 3. Remove the 10 pin Molex connector from the customer connection board. If the message clears the problem is with external sensor wiring. Examine the external sensor wiring for shorts to the ground, repairing as necessary. If the message is still present and the boiler is so equipped, disconnect the UL 353 low water cut-off to see if the message clears. Replace the faulty part. Check the low voltage wire harness in boiler for shorts to ground. 4. If a message only occurs when the burner tries to light, check the gas valve for excessive current draw. 5. If a message is present when the low voltage harness is disconnected from the 926 control board, replace the 926 control board.
WATER HIGH TEMP F00 PUMP ON	F00 indicates the water in the boiler has overheated. The boiler will not restart until it cools sufficiently and a technician determines and repairs the cause of overheating and pushes RESET on the display. This is a serious safety issue as indicated by the illuminated red light and the word LOCKOUT flashing on the display. During this lockout fault, the pump will be on in an effort to cool the boiler down.	<ol style="list-style-type: none"> 1. Check circulator pump operation. 2. If the circulator pump is running, ensure there is water in the system and that the water is moving through the system as intended. Ensure that all correct ball valves and or zone valves are open or closed as intended. 3. Observe the temperature/pressure gauge. If the water is not too hot and this message is displayed, check the wiring to the water ECO sensor and repair if necessary. If the wiring is ok and this code is still present and the water is not excessively hot, replace the ECO sensor.
Screen	Description	Possible Remedy
FLUETEMP/WAT LV F01 PUMP ON	<p>This code indicates that one of the safety interlock switches present in the unit has tripped. There are several interlock switches that could possibly trip and cause this error. The following four switches are installed and are standard equipment in all boilers.</p> <ol style="list-style-type: none"> 1. Flue ECO – Trips if the flue temperature is excessive. This switch has to be manually reset. 2. Boiler module thermal fuse – Trips if there is excessive heat on the rear of the heat exchanger. 3. Boiler module front temperature switch - Trips if there is excessive heat on the front of the heat exchanger. 4. Blocked vent pressure switch (BVPS) – This switch trips if there is excessive pressure in the flue and automatically resets. <p>The following switches are optional equipment that may be installed on the boiler. These devices have indicator lights on them showing of they are tripped.</p> <ol style="list-style-type: none"> 1. High gas pressure switch – This switch trips if there is excessive gas pressure on the outlet side of the gas valve and must be manually reset. 2. Low gas pressure switch – This switch trips if there is low gas pressure on the inlet side of the gas valve and must be manually reset. 3. UL 353 Low Water Cutoff – This device trips if the water level in the boiler is low and must be manually reset. 	<ol style="list-style-type: none"> 1. Check to see if the boiler with the F01 code displayed has any of the optional switches installed. 2. If so, check to see if the indicator light on any of the devices is showing that they are tripped. 3. If an indicator light is illuminated, investigate the source of the error for that particular switch. 4. If there are no optional switches or none of the indicator lights is illuminated on the optional switches then use an ohmmeter to test each of the standard switches one at a time. Turn the power off to the boiler and disconnect the switch to be tested from the boiler to determine which one has tripped. <p>When you find the tripped switch investigate the cause of the fault based on the purpose of the switch. NOTE: The common reasons for the temperature switches to trip are a) low water flow through the boiler, or b) poor heat transfer from the water to the load.</p> <ol style="list-style-type: none"> 5. If no switches are tripped, push RESET on the boiler. If the boiler tries to ignite or ignites and only runs for a short time and the F01 code returns, investigate the flue for blockage.

SUPPLY SENSOR F02 PUMP ON	F02 indicates the supply temperature sensor of the boiler has failed. The boiler will not restart until a technician replaces the sensor and pushes RESET on the display. This is a serious safety issue as indicated by the illuminated red light and the word LOCKOUT flashing on the display. During this lockout fault, the pump will be on.	1. Check the electrical connection to the thermistor on the outlet manifold. Verify 5 VDC by checking the Molex connector. If there is no 5 VDC, check the harness. If harness is OK, replace the control. Verify thermistor values by referencing chart in this manual. 2. Replace thermistor if necessary. NOTE: The boiler will reset automatically once the fault is corrected.
RETURN SENSOR F03 PUMP ON	F03 indicates the return temperature sensor of the boiler has failed. The boiler will not restart until a technician replaces the sensor and pushes RESET on the display. This is a serious safety issue as indicated by the illuminated red light and the word LOCKOUT flashing on the display. During this lockout fault, the pump will be on.	1. Check circulator pump operation. 2. Ensure adequate flow through the boiler by accessing the status menu and determining there is less than a 50°F rise from the return thermistor to the supply thermistor. 3. Troubleshoot thermistor by following the steps in F02.
FLUE SENSOR F04 PUMP ON	F04 indicates that the flue temperature sensor of the boiler has failed. The boiler will not restart until a technician replaces the sensor and pushes RESET on the display. This is a serious safety issue as indicated by the illuminated red light and the word LOCKOUT flashing on the display. During this lockout fault, the pump will be on.	Inspect the flue sensor for physical damage or corrosion and replace it if necessary. Check the electrical connection to the flue sensor and repair as necessary. Measure the resistance of the sensor and refer to the sensor resistance table in this manual. The temperature on the chart should be close to the temperature in the flue. If not, replace the flue sensor.
Screen	Description	Possible Remedy
SUPPLY TEMP HIGH F05 PUMP ON	F05 indicates the boiler supply temperature is excessive. When accompanied by the red FAULT light and LOCKOUT flashing on the display, this code indicates the supply sensor temperature has exceeded 230°F and a serious safety issue exists. The boiler will not restart until a technician determines and repairs the cause of excessive temperature and pushes RESET on the display. If the FAULT light is not illuminated and this message is displayed, the supply temperature of the boiler is at or above 210°F. The message will clear automatically when the temperature drops below 194°F. During the time that this fault is displayed, the pump will be on.	1. Check circulator pump operation. 2. Ensure adequate flow through the boiler by accessing the status menu and determining there is less than a 50°F rise from the return thermistor to the supply thermistor. 3. Check the direction of flow off the boiler circulator. (See Piping Details in this manual.) 4. Troubleshoot the thermistor by following steps in F02.
RETURN TEMP HIGH F06 PUMP ON	This display indicates that the boiler return temperature is excessive. When accompanied by the red FAULT light and LOCKOUT flashing on the display, this code indicates that the return sensor temperature has exceeded 230°F and a serious safety issue exists. The boiler will not restart until a technician determines and repairs the cause of excessive temperature and pushes RESET on the display. If the red FAULT light is not illuminated and this message is displayed, then the return temperature of the boiler is at or above 210°F. The message will clear automatically when the temperature drops below 194°F. During the time that this message or lockout fault is displayed, the pump will be on.	1. Check circulator pump operation. 2. Ensure adequate flow through the boiler by accessing the status menu and determining there is less than a 50°F rise from the return thermistor to the supply thermistor. 3. Check the direction of flow on boiler circulator. (See Piping Details in this manual.) 4. Troubleshoot thermistor by following steps in F02.

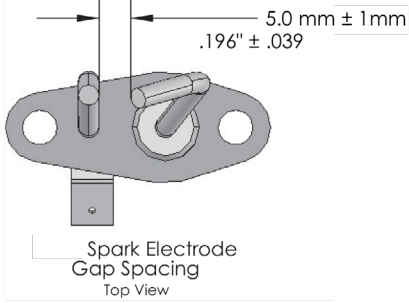
<p>NO FLAME ON IGN F09 PUMP ON</p>	<p>The boiler tried to ignite four times during one heat call and failed. This is a serious safety issue as indicated by the illuminated red light and the word LOCKOUT flashing on the display. The boiler will not restart until a technician determines and repairs the cause of ignition failure and pushes RESET on the display. During this lockout fault, the pump will remain on.</p>	<ol style="list-style-type: none"> 1. Watch the igniter through the observation window. 2. If there is no spark, check the spark electrode for the proper .196" (5.0 mm ± 1mm) gap. See below. 3. Remove any corrosion from the spark electrode and flame rectifier probe. 4. If there is a spark but no flame, check the gas supply to the boiler. 5. If there is a flame, check the flame sensor. 6. Check any flue blockage or condensate blocks.  <p style="text-align: center;">Spark Electrode Gap Spacing Top View</p> <p>NOTE: If receiving an F09 fault code, check the gap spacing between points on the electrode.</p>
<p>FLAME LOSS F10 PUMP ON</p>	<p>The flame was lost 3 times while the boiler was firing during 1 demand call. This is a serious safety issue as indicated by the illuminated red light and the word LOCKOUT flashing on the display. The boiler will not restart until a technician determines and repairs the cause of flame loss and pushes RESET on the display. During this lockout fault, the pump will be on.</p>	<ol style="list-style-type: none"> 1. Monitor gas pressure to the unit while in operation. 2. Assure the flame is stable when lit. 3. Check if the display readout changes from "GAS VALVE ON" to "RUN" within a few seconds of boiler ignites. 4. Check the FLAME signal on the display. It should be above 1.0 when the boiler is firing. 5. If the signal reads less than 1 microampere, clean the flame rectifier and spark probe. 6. If the problem persists and the "FLAME" signal is still less than 1.0, replace the flame probe and spark igniter probe. 7. The flame signal should be steady after the boiler has been firing for 1 minute and is normally at 5.0 to 9.0. If the flame signal is not steady, disassemble the burner door and check the burner and its sealing gaskets.
<p>FALSE FLAME SIG F11 PUMP ON</p>	<p>There is flame when the control is not telling the boiler to run. This is a serious safety issue as indicated by the illuminated red light and the word LOCKOUT flashing on the display. The boiler will not restart until a technician determines and repairs the cause and pushes RESET on the display. During this lockout fault, the pump will be on.</p>	<ol style="list-style-type: none"> 1. Look into window. If there is flame, turn the gas off to the unit at the service valve and replace the gas valve. 2. If the flame signal on the status menu is greater than 1.0 when the burner is not lit, replace the spark ignitor and the flame rectification probe. 3. If the flame signal is not present after turning off the gas supply, check the gas valve electrical connection. 4. Check for condensate backup. Repair condensate system as necessary. If condensate has partially filled the combustion chamber, the refractory wall may be damaged and should be replaced. 5. Turn the gas on at the service valve after corrective action is taken. 6. If the refractory wall falls against the rectifier probe, it may conduct the signal to ground, giving a false reading.
<p>FAN SPEED ERROR F13 PUMP ON</p>	<p>The fan is not running at the speed determined by the control. Fan speed has been more than 30% faster or slower than the commanded speed for more than 10 seconds. This is a serious safety issue as indicated by the illuminated red light and the word LOCKOUT flashing on the display. This boiler will not restart until a technician determines and repairs the cause and pushes RESET on the display. During this lockout fault, the pump will be on.</p>	<ol style="list-style-type: none"> 1. Check the combustion fan wiring. 2. Measure DC voltage from the red fan wire to ground while it is connected to the fan. It should be between 24 and 40 volts. If it is lower than 24 volts, check for excessive external loads connected to the boiler sensor terminals 3. Disconnect the 5 pin plug from the fan and check the voltage on the red wire again. If it is now between 24-40 volts, replace the fan. If it is still below 24 volts replace the boiler control board.

FLAP CLOSED F15	Flapper valve physically stuck closed.	<ol style="list-style-type: none"> 1. Check flue system for obstructions. 2. Check proper communication between boilers. 3. Check operation of flapper valve. 4. Check wiring between valve and controller. 5. Replace valve-flapper.
FLAP OPEN F16	Flapper valve physically stuck open.	<ol style="list-style-type: none"> 1. Check flue system for obstructions. 2. Check proper communication between boilers. 3. Check operation of flapper valve. 4. Check wiring between valve and controller. 5. Replace valve-flapper.
CONDENSATE FULL F20 PUMP OFF	The condensate trap is full. This is a serious safety issue as indicated by the illuminated red light and the word LOCKOUT flashing on the display. The boiler will not restart until a technician determines and repairs the cause and pushes RESET on the display. During this lockout fault, the pump will be off.	<ol style="list-style-type: none"> 1. Check condensate lines for obstructions. 2. Check float switch in condensate reservoir. 3. Check wiring from condensate reservoir to 926 control and repair as necessary.
Screen	Description	Possible Remedy
PROGRAM ERROR F31 PUMP OFF	There was an error while programming the control and the memory is corrupt. The boiler control will not function in this state and the pump will be off as indicated on the bottom line. This error only occurs if a technician is programming the control and the programming function fails. The only way to recover from this error is to reprogram the control. If this error occurs at any time other than when a technician is servicing the boiler, the control has failed and must be replaced by a qualified technician.	The control must be reprogrammed. If programming does not solve the problem, the control must be replaced.
CONTROL PROGRAMED PP	The control has been programmed by a technician or the factory. After programming, the control is left in a locked out mode.	Press RESET for at least 1 second to use the control.
OUTDOOR SENSOR FOU PUMP ON 1:45P	There is an issue with the outdoor sensor. It is shorted, damaged, or disconnected from the boiler.	<ol style="list-style-type: none"> 1. Check outdoor sensor connections and wiring. Ensure the sensor and wiring are intact and that the sensor is connected to the boiler. 2. Check the outdoor sensor resistance with an ohmmeter. See Table 28 for correct outdoor sensor resistance. 3. Replace the outdoor sensor.
The following blocking codes will block operation until the control determines the situation safe for boiler operation.		
FLUE TEMP HIGH E07 PUMP OFF TIME	E07 indicates the flue sensor temperature is excessive and above 210°F. When E07 is displayed the boiler will not respond to a demand for heat. When the flue temperature decreases below 194°F, the display will return to normal and allow the boiler to respond to a heat demand. The bottom line indicates the status of the pump. The pump will remain off when this error is displayed.	Check the flue for obstructions and any sign of damage, especially signs of excessive heat. Repair as necessary. Run the boiler and check the flue temperature with an external thermometer. If the flue temperature on the thermometer does not agree with the flue temperature displayed in the status menu, inspect the wiring to the flue temperature sensor in the boiler and repair as necessary. If the wiring is intact replace the flue sensor. If the flue temperature is excessive on the status menu and the test thermometer reads the same, check and adjust combustion controls on the boiler. If the problem persists, inspect the target wall in the combustion chamber and replace it if cracked or damaged.
COMMON FLUE BLOCK E16	Common flue blocking or flapper valve feedback failure.	<ol style="list-style-type: none"> 1. Ensure boiler is properly programmed. 2. Check flue system for obstructions. 3. Check proper communication between boilers. 4. Check operation of flapper valve. 5. Check wiring between valve and controller. 6. Replace valve-flapper.
LINE VOLTAGE PUMP OFF E19	E19 indicates the line voltage frequency is out of range. This could happen if the boiler is being powered from a small gasoline powered generator that is overloaded or not functioning correctly.	Inspect power wiring to the boiler and repair as necessary. If connected to line voltage, notify the power company. If connected to an alternate power source such as a generator or inverter, make sure the line voltage frequency supplied by the device is 60 Hz.

Table 27 - Boiler Error and Fault Codes

Part 13 - Maintenance

A. Procedures

Periodic maintenance should be performed once a year by a qualified service technician to assure that all the equipment is operating safely and efficiently. The owner should make necessary arrangements with a qualified heating contractor for periodic maintenance of the boiler. The installer must also inform the owner that a lack of proper care and maintenance of the boiler may result in a hazardous condition.

WARNING

BEFORE EACH HEATING SEASON a trained and qualified service technician should perform the inspections as per the boiler inspection and maintenance schedule in this manual. Failure to do so could result in death or serious injury.

The combustion chamber insulation in this product contains ceramic fiber material. Ceramic fibers can be converted to cristobalite in very high temperature applications. The International Agency for Research on Cancer (IARC) has concluded, "Crystalline silica inhaled in the form of quartz or cristobalite from occupational sources is carcinogenic to humans (Group 1)."

- Avoid breathing dust and contact with skin and eyes.
- Use a NIOSH certified dust respirator (N95). This type of respirator is based on the OSHA requirements for cristobalite at the time this document was written. Other types of respirators may be needed depending on job site conditions. Current NIOSH recommendations can be found on the NIOSH website: <http://www.cdc.gov/niosh/homepage.html>. NIOSH approved respirators, manufacturers, and phone numbers are also listed on this website.
- Wear long-sleeved, loose fitting clothing, gloves, and eye protection.
- Apply enough water to the combustion chamber lining to prevent dust.
- Wash potentially contaminated clothes separately from other clothing. Rinse clothes washer thoroughly.

NIOSH stated First Aid.

- Eye: Irrigate immediately.
- Breathing: Fresh air.

B. Combustion Chamber Coil Cleaning Instructions

*Before beginning this procedure, have on hand the following items:

- a nylon, stainless steel, or brass brush (not steel)
- gloves and eye protection

1. Shut down the boiler by using the following steps:

- a. Close the gas valve. Shut down the unit, and wait for it to be cool to the touch.
- b. Disconnect the condensate piping from the outside connection, (not from the boiler side), so flow from condensate reservoir can be observed.
- c. Disconnect electrical connections from the gas valve, spark electrode, flame rectification probe, and combustion blower.
- d. Remove the four (4) screws on the aluminum 3/4" NPT connector on the right side of the gas valve.
- e. Disconnect the wiring connected to the combustion blower motor.
- f. Remove the six (6) 10MM nuts from the burner plate assembly.
- g. Pull the entire burner plate assembly with blower still attached towards you, while removing or pushing aside any wiring to allow removal of the assembly.

2. Spray the coils liberally with a spray bottle filled with clear tap water. Confine the spray to the area being cleaned. Avoid getting the ceramic target wall wet. If the condensate system is blocked, use a vacuum to clear it.

Outdoor Sensor (7250P-319)		Supply Temperature Sensor (7250P-324) Boiler Sensor (7250P-667) Indirect Sensor (7350P-325)	
Outside Temperature (°F)	Resistance (ohms)	High / Low Temp Sensor Temp. (°F)	Resistance (Ohms)
-22	171800	32	32550
-13	129800	41	25340
-4	98930	50	19870
5	76020	59	15700
14	58880	68	12490
23	45950	77	10000
32	36130	86	8059
41	28600	95	6535
50	22800	104	5330
59	18300	113	4372
68	14770	122	3605
77	12000	131	2989
86	9804	140	2490
95	8054	149	2084
104	6652	158	1753
113	5522	167	1481
		176	1256
		185	1070
		194	915
		202	786
		212	667

Table 28 - Sensor Temperature Resistance

3. Scrub coils of any buildup with a nylon, stainless steel, or brass brush. Do not use a steel brush. Vacuum the debris from the coils.

4. Spray the coils again with clear tap water. Confine the spray to the area being cleaned. Flush the combustion chamber with fresh water until it runs clear from the condensate reservoir. At this point, the boiler should be ready to be reassembled.

- a. Inspect gaskets.
- b. Reinstall the burner assembly
- c. Replace and tighten the six (6) 10MM nuts to the burner plate using staggered tightening sequence. (See detail.)
- d. Reconnect all wiring connections
- e. Inspect the gas valve. Ensure the O-ring is in place.
- f. Replace the four (4) screws on the aluminum connector on the gas valve. Turn the gas back on. (IMPORTANT: CHECK FOR GAS LEAKS!)
- g. Turn boiler power back on and create a heat demand. When boiler is lit observe condensate flow from the boiler. Be sure the boiler is operating properly.
- h. Reconnect the condensate piping to the outside condensate connection.

WARNING

Do not use solvents to clean any of the burner components. The components could be damaged, resulting in unreliable or unsafe boiler operation, substantial property damage, severe personal injury, or death.

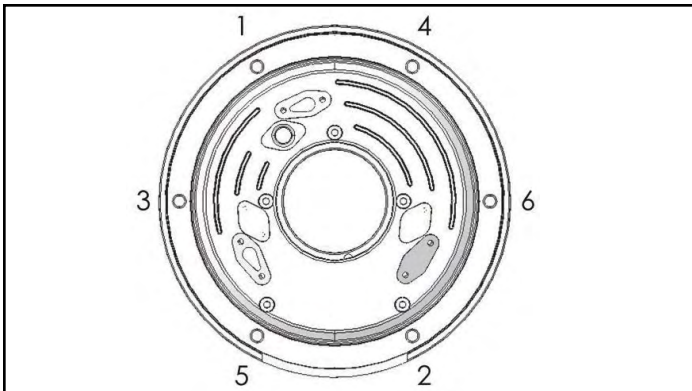

Figure 31 - Heat Exchanger Detail

C. Cleaning Water Side of Heat Exchanger

1. Make sure power is turned off to the boiler. Run water through the hot water system to ensure it is below room temperature.

2. Close isolation valves on the return and supply connections to the boilers as shown in the piping diagrams in this manual. Slowly open the ball valves and release pressure into a bucket. Once pressure is released, connect a hose to the water line to flush the boiler. Scale removing solution may be used, but must be approved for use with stainless steel and FDA approved for use in a potable water system.

3. Thoroughly flush the heat exchanger before commissioning the unit back in service.

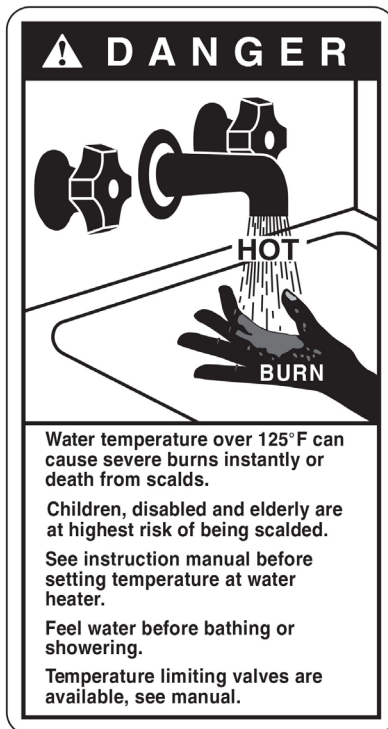

Part 14 - Installation Checklist

Light Off Activities		Date Completed:	
1. Fill the Heating System	Check all piping and gas connections. Verify all are tight.		
	Pressurize system.	PSI	
	Add water to prime condensate cup.		
	Verify near boiler piping is properly supported.		
2. Check Gas Pipe	Leak test using locally approved methods (consult jurisdictional code book).		
	Check incoming gas pressure (3.5 to 14" WC).	Static WC	
	Check the "drop" on light off (less than 1" WC).	Dynamic WC	
3. Check Combustion	Check and adjust (if necessary) carbon dioxide content.	%CO2 High Fire	%CO2 Low Fire
	Check and adjust (if necessary) carbon monoxide content.	ppm CO High Fire	ppm CO Low Fire
4. Check Electrical Connections	Ensure all electrical connections of line voltage (pumps, etc.) and low voltage circuits (system sensor, outdoor sensor, etc.) are properly wired.		
5. Verify System Operation with Indirect Water Heater Aquastat	Turn up aquastat to verify wiring connections. Boiler should fire.		
6. Record Ionization Current	Check uA reading at d7 on the status menu (see Start-Up section, this manual).	uA High Fire	uA Low Fire
7. Indirect Water Heater Sensor	Verify safety and operation of the indirect water heater. Record settings.	DHW Setpoint	DHW Differential
8. System Settings	Verify system settings.	CH Setpoint	CH Differential
9. Convert the Boiler (1000 Model ONLY)	If necessary, convert the boiler to the proper fuel type.		
	Locate the stickers in the appropriate locations on the boiler.		
	Verify combustion settings after gas conversion - Carbon Dioxide.	%CO2 High Fire	%CO2 Low Fire
	Verify combustion settings after gas conversion - Carbon Monoxide.	ppm CO High Fire	ppm CO Low Fire
	Mail in conversion registration.		
Notes:			

Table 29 - Installation Checklist

Part 15 - Maintenance Report

CAUTION
In unusually dirty or dusty conditions, care must be taken to keep boiler cabinet door in place at all times. Failure to do so VOIDS the warranty.
 WARNING
Allowing the boiler to operate with a dirty combustion chamber will hurt operation. Failure to clean the heat exchanger as needed by the installation location could result in boiler failure, property damage, personal injury, or death. Such product failures ARE NOT covered under warranty.

The boiler requires minimal periodic maintenance under normal conditions. However, in unusually dirty or dusty conditions, periodic vacuuming of the cover to maintain visibility of the display and indicators is recommended.

Periodic maintenance should be performed once a year by a qualified service technician to assure that all the equipment is operating safely and efficiently. The owner should make necessary arrangements with a qualified heating contractor for periodic maintenance of the boiler. Installer must also inform the owner that the lack of proper care and maintenance of the boiler may result in a hazardous condition.

Inspection Activities		Date Last Completed			
Piping		1st Year	2nd Year	3rd Year	4th Year*
Near boiler piping	Check boiler and system piping for any sign of leakage; make sure pipes are properly supported.				
Vent	Check condition of all vent pipes and joints. Ensure the vent piping terminations are free of obstructions and blockages.				
System		1st Year	2nd Year	3rd Year	4th Year*
Visual	Do a full visual inspection of all system components.				
Functional	Test all functions of the system (Heat, Safeties).				
Temperatures	Verify safe settings on boiler or anti-scald valve.				
	Verify programmed temperature settings.				
Electrical					
Connections	Check wire connections. Make sure connections are tight.				
Smoke and CO Detector	Verify devices are installed and working properly. Change batteries if necessary.				
Circuit Breakers	Check to see that the circuit breaker is clearly labeled. Exercise circuit breaker.				
Switch and Plug	Verify ON/OFF switch and convenience plug are both functional.				
Chamber / Burner		1st Year	2nd Year	3rd Year	4th Year*
Combustion Chamber	Check burner tube and combustion chamber coils. Clean according to maintenance section of manual. Vacuum combustion chamber. Replace any gaskets that show signs of damage.				
Spark Electrode	Clean. Set gap at 1/4" Clean probe with plumbers cloth to remove oxides.				
Combination Ignitor and Flame Probe	Check ionization in uA (d7 in Status Menu in Start-Up Procedures). Record high fire and low fire. Clean probe with plumbers cloth to remove oxides.				
Condensate		1st Year	2nd Year	3rd Year	4th Year*
Neutralizer	Clean out condensate neutralizer. Use wet/dry vacuum. Check for all potential obstruction issues. Replenish marble chips or lime crystals if needed (no smaller than 3/4"). Refill system with water. WARNING: You must verify flow of condensate and make sure the cap is connected properly before leaving boiler unattended.				
Condensate System	Check entire condensate system to make sure there are no obstructions in flow. Make sure the condensate pump is working properly, verify all connections.				
Gas		1st Year	2nd Year	3rd Year	4th Year*
Pressure	Measure incoming gas pressure (3.5 to 14"WC).				
Pressure Drop	Measure drop in pressure on light off (no more than 1"WC).				
Check Gas Pipe for Leaks	Check gas piping. Test for leaks and signs of aging. Make sure all pipes are properly supported.				
Combustion		1st Year	2nd Year	3rd Year	4th Year*
CO / CO2 Levels	Check CO and CO2 levels in exhaust. See Start-Up Procedures for ranges. Record at high and low fire.				
Safeties		1st Year	2nd Year	3rd Year	4th Year*
ECO (Energy Cut Out)	Check continuity on flue and water ECO. Replace if corroded.				
Sensors	Check wiring. Verify through ohms reading.				
Final Inspection		1st Year	2nd Year	3rd Year	4th Year*
Check List	Verify that you have completed entire check list. WARNING: FAILURE TO DO SO COULD RESULT IN SERIOUS INJURY OR DEATH.				
Homeowner	Review what you have done with the homeowner.				

Table 30 - *Continue annual maintenance beyond the 4th year as required.

Part 16 - Replacement Parts

1000 Model

ITEM #	DESCRIPTION	REPLACEMENT PART#
1	ADAPTER, OFFSET, 2 DEGREE S.S.	7350P-328
2	ECCENTRIC, FEMALE, 2 DEGREE, S.S.	7350P-336
3	TEE, BOOT, EXHAUST, S.S.	7350P-335
4	TAPERED INCREASER, S.S.	7350P-334
5	CUSTOM PIECE, 12" LONG, S.S.	7350P-330
6	VENT LENGTH, S.S.	7350P-332
7	ELBOW, 88 DEGREE, S.S.	7350P-331
8	ADAPTER, FNS, S.S.	7350P-329
9	RETURN MANIFOLD	7350P-376
10	SUPPLY MANIFOLD (w/ SENSOR, HARNESS)	7350P-377
11	ASSY GAS PIPING	7350P-744
12	LEVELING FOOT/MOUNT SUPPORT	7350P-317
13	STACKING ASSEMBLY	7350P-616
14	CAT 5 CABLE (NOT SHOWN)	7350P-745
15	SYSTEM SENSOR	7250P-667
16	SHUT-OFF BALL VALVE	7350P-281
17	SYSTEM SENSOR WIRE HARNESS (NOT SHOWN)	7350P-746

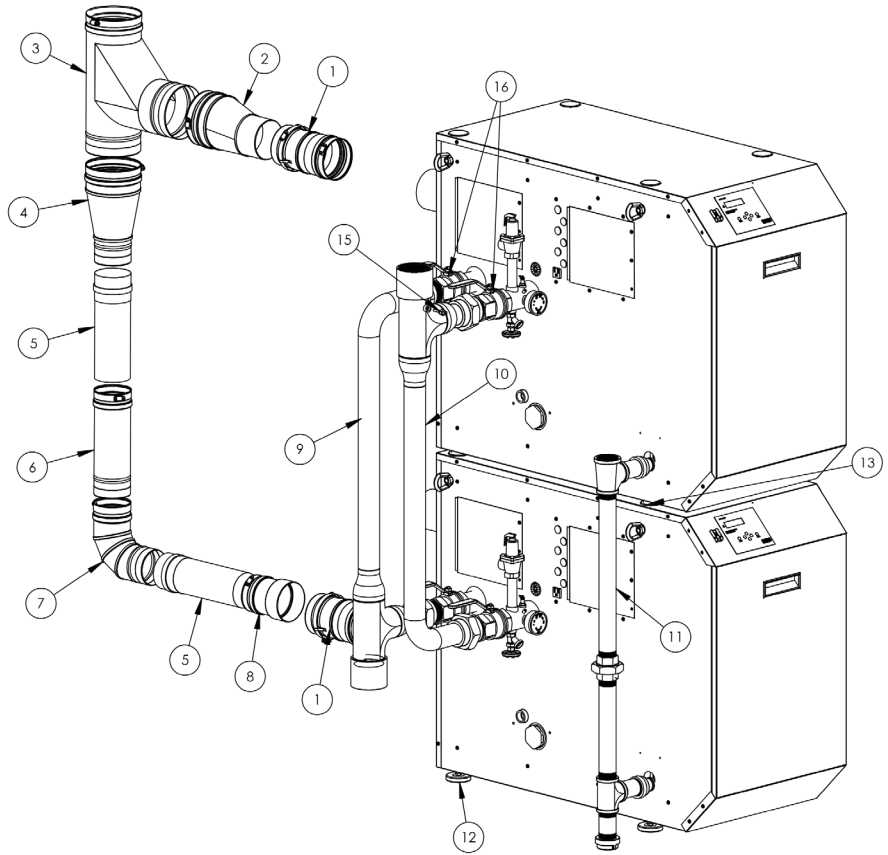

LP-428-A
02/23/17

Figure 32 - 1000 Model External Replacement Parts

1700 Model

ITEM#	DESCRIPTION	REPLACEMENT PART #
1	INCREASER, ECCENTRIC S.S.	7350P-344
2	BOOT TEE, S.S.	7350P-343
3	TAPERED INCREASER, S.S.	7350P-342
4	CUSTOM LENGTH, 12", S.S.	7350P-341
5	VENT LENGTH, 12" S.S.	7350P-340
6	ELBOW, 90 DEGREE, S.S.	7350P-339
7	CUSTOM LENGTH, 15", S.S.	7350P-338
8	RETURN MANIFOLD	7350P-376
9	SUPPLY MANIFOLD (w/SENSOR, HARNESS)	7350P-377
10	ASSY GAS PIPING	7350P-743
11	LEVELING FOOT/MOUNT SUPPORT	7350P-317
12	STACKING ASSEMBLY	7350P-616
13	CAT 5 CABLE (NOT SHOWN)	7350P-745
14	SYSTEM SENSOR	7250P-667
15	SHUT-OFF BALL VALVE	7350P-281
16	SYSTEM SENSOR HARNESS (NOT SHOWN)	7350P-747

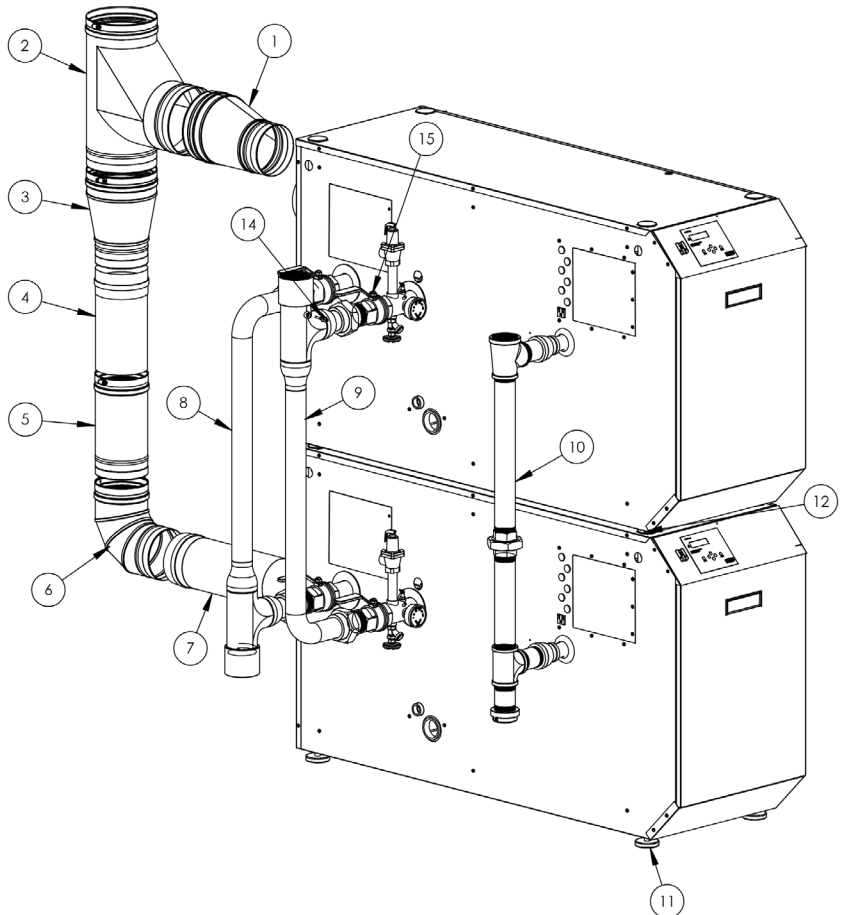

LP-428-B
02/22/17

Figure 33 - 1700 Model External Replacement Parts

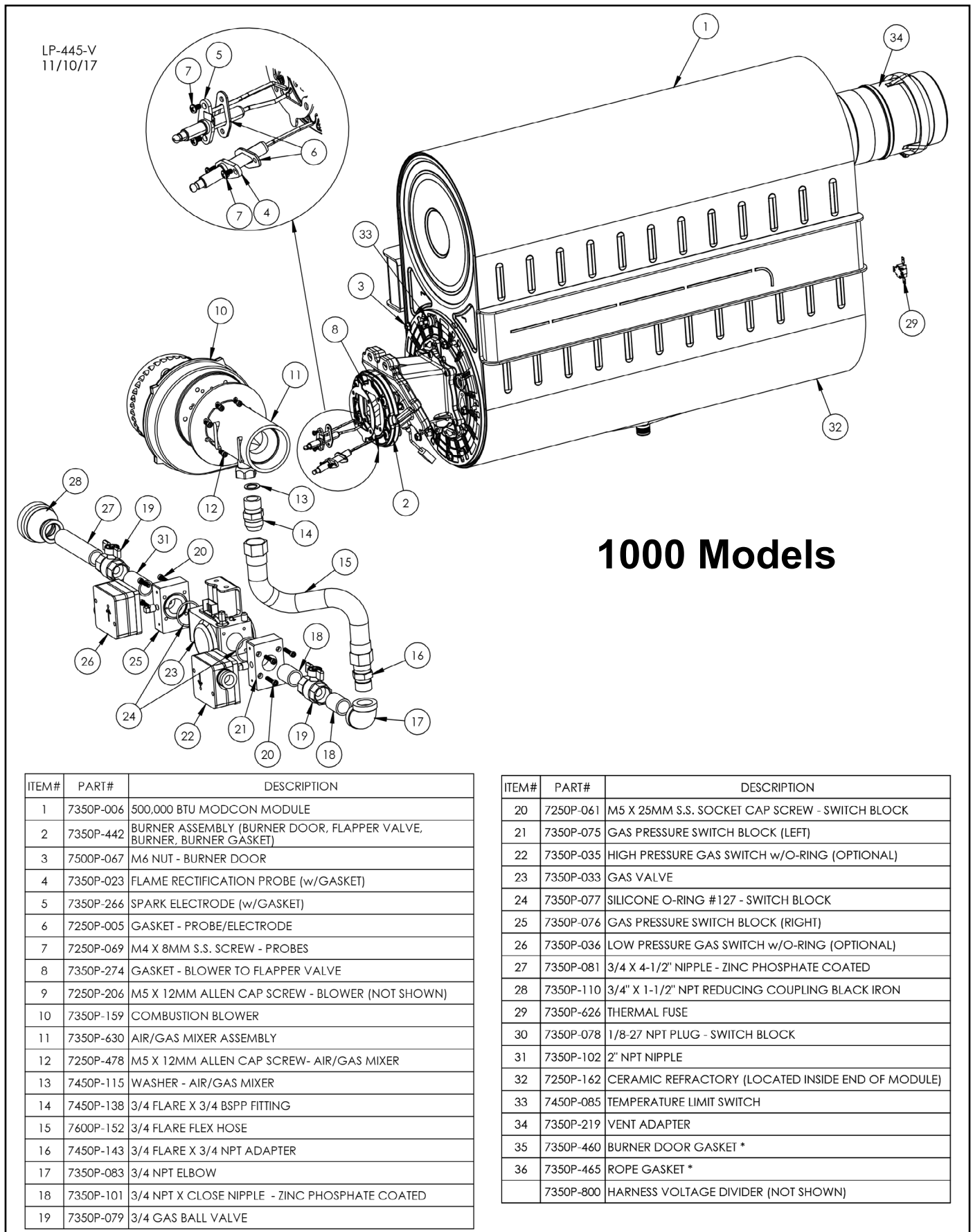
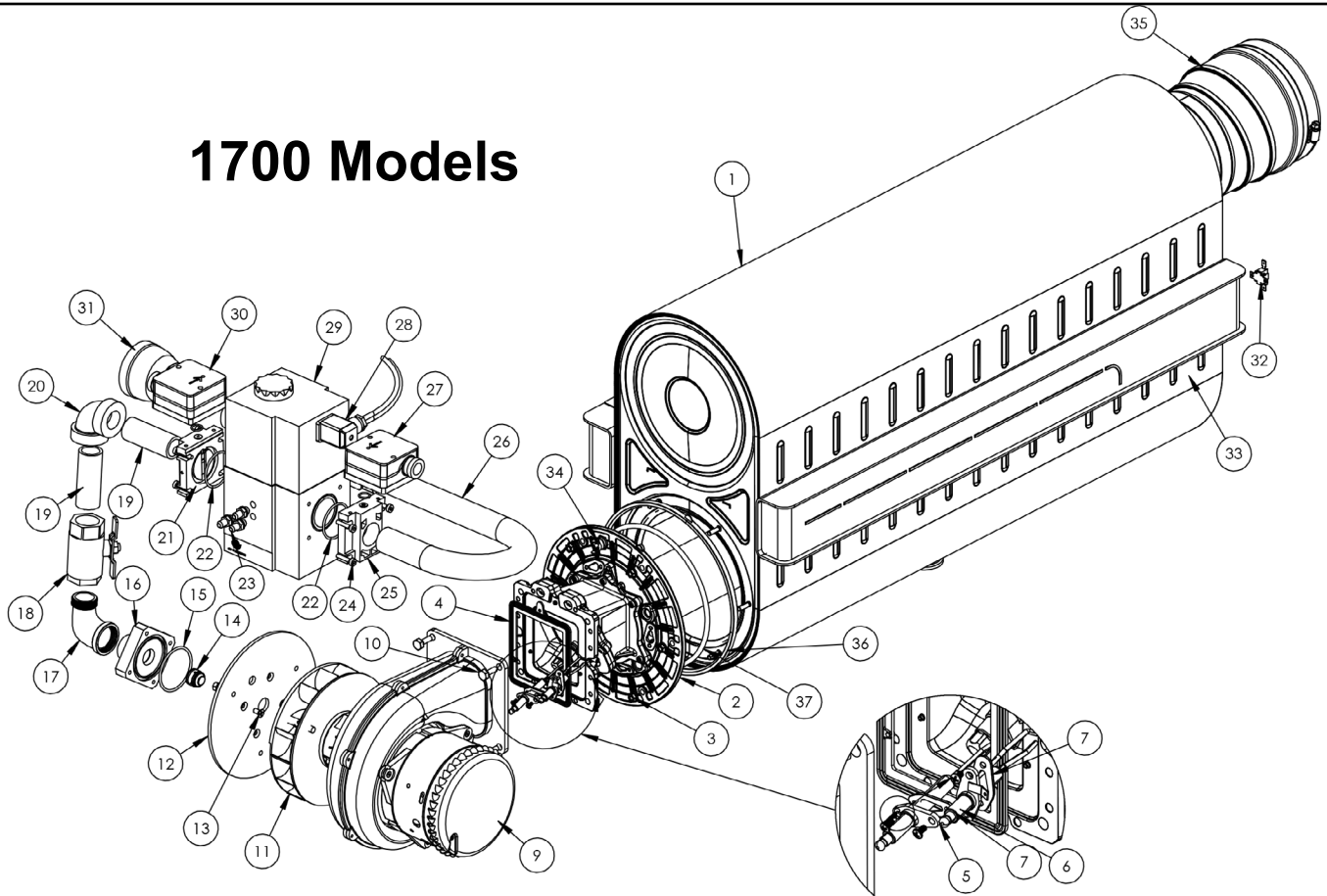

Figure 34 - 1000 Model Combustion System Replacement Parts - *Not Shown

1700 Models



ITEM#	PART#	DESCRIPTION
1	7350P-007	850,000 BTU MODULE
2	7350P-443	BURNER ASSEMBLY (BURNER DOOR, FLAPPER VALVE, BURNER, BURNER GASKET)
3	7500P-067	M6 NUT - BURNER DOOR
4	7350P-064	GASKET - BLOWER TO FLAPPER VALVE
5	7350P-023	FLAME RECTIFICATION PROBE (w/GASKET)
6	7350P-266	SPARK ELECTRODE (w/GASKET)
7	7250P-005	GASKET - PROBE/ELECTRODE
8	7250P-069	M4 X 8MM CHEESE HEAD PHILLIPS SCREWS - PROBE/ELECTRODE
9	7350P-238	COMBUSTION BLOWER
10	7350P-093	M8 X 20MM HEX HEAD BOLT - BLOWER
11	7350P-034-11	SWIRL PLATE
12	N/A	MOUNTING PLATE
13	N/A	M6 X 24MM FLAT HEAD SCREW - ADAPTER FLANGE
14	N/A	O-RING - BLOWER ADAPTER FLANGE
15	7350P-034-4	12MM GAS INJECTOR
16	7350P-034-2	BLOWER ADAPTER FLANGE (includes O-RING, SCREWS)
17	7350P-096	1" M X 1" F STREET ELBOW - ZINC PHOSPHATE COATED
18	7350P-099	1" GAS BALL VALVE

ITEM#	PART#	DESCRIPTION
19	7350P-098	1" NPT X 3" NIPPLE - ZINC PHOSPHATE COATED
20	7350P-095	1" NPT 90 DEGREE ELBOW
21	7350P-034-3	MAXIMUM FLOW RESTRICTOR FLANGE
22	N/A	O-RING - FLANGES
23	7350P-034-6	AIR ADJUSTMENT PORTS
24	N/A	M6 X 25MM SCREWS - FLANGE
25	7350P-034-5	1" NPT FLANGE
26	7350P-082	GAS PIPE ASSY w/SHUT-OFF - 1-1/4 IPS X 1 IPS
27	7350P-036	LOW PRESSURE GAS SWITCH w/O-RING (OPTIONAL)
28	7350P-034-8	HIRSCHMAN CONNECTOR
29	7350P-034	GAS VALVE (Includes O-ring, Screws)
30	7350P-035	HIGH PRESSURE GAS SWITCH w/O-RING (OPTIONAL)
31	7350P-109	1-1/4" - 2" REDUCING COUPLING
32	7350P-626	THERMAL FUSE
33	7250P-162	CERAMIC REFRACTORY (LOCATED INSIDE END OF MODULE)
34	7450P-085	TEMPERATURE LIMIT SWITCH
35	7350P-355	VENT ADAPTER
36	7350P-460	BURNER DOOR GASKET
37	7350P-465	ROPE GASKET
	7350P-800	HARNES VOLTAGE DIVIDER

LP-428-CC
11/10/17

Figure 35 - 1700 Model Combustion System Replacement Parts

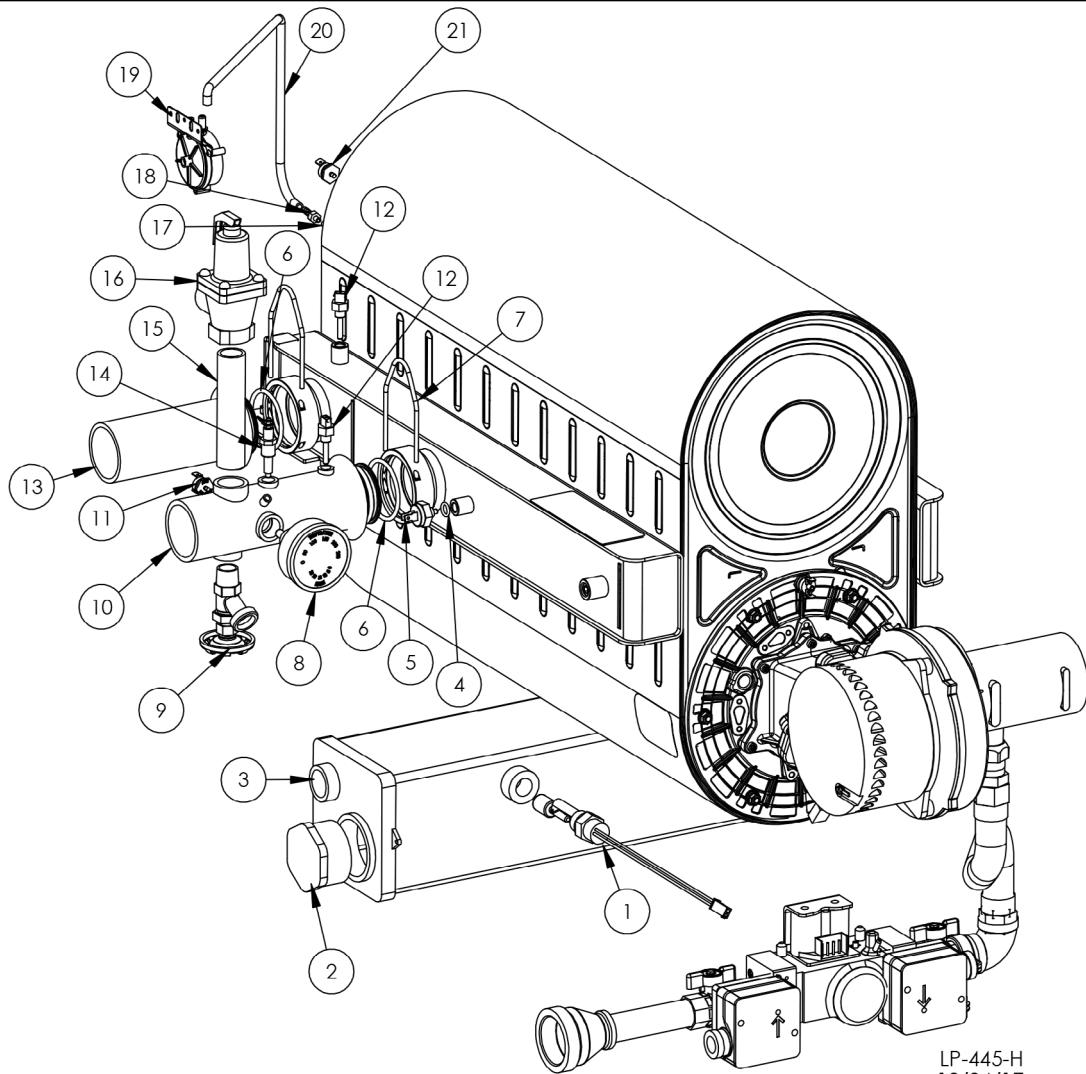

LP-445-H
10/04/17

Item#	1000	1700	Description
1	7350P-167	7350P-167	CONDENSATE OVERFLOW SWITCH
2	7350P-113	7350P-113	2" PVC PLUG
3	7350P-613	7350P-613	CONDENSATE COLLECTOR
4	7500P-100	7500P-100	O-RING - ECO HIGH LIMIT SENSOR
5	7500P-033	7500P-033	ECO HIGH LIMIT SENSOR (w/O-RING)
6	7350P-072	7350P-072	O-RING - INLET/OUTLET NIPPLE
7	7350P-015	7350P-015	INLET/OUTLET NIPPLE CLIP
8	7250P-499	7250P-499	TEMP/PRESSURE GAUGE 200 PSI
9	7350P-277	7350P-277	SHUT-OFF DRAIN
10	7350P-318	7350P-318	OUTLET NIPPLE (w/O-RING)
11	7500P-002	7500P-002	ECO SWITCH - 190 DEG.
12	7250P-667	7250P-667	THERMISTOR
13	7350P-004	7350P-004	INLET NIPPLE
14	7350P-089	7350P-089	LOW WATER CUT-OFF PROBE
15	SN1018	SN1018	3/4" NPT X 3" NIPPLE - BRASS
16	7350P-223	7350P-223	75# RELIEF VALVE - 3/4" NPT
17	7250P-152	7250P-152	SILICONE O-RING 2-007 - BARBED FITTING
18	7250P-154	7250P-154	S.S. BARBED FITTING - 1/4 HOSE X 10-32
19	7250P-150	7250P-150	BLOCKED VENT PRESSURE SWITCH
20	7000P-805	7000P-805	PLASTIC TUBING 3/16 ID X 5/16 OD X 12"
21	7250P-739	7250P-739	FLUE ECO SWITCH - 160 DEG.

Figure 36 - Water Side Replacement Parts - All Models

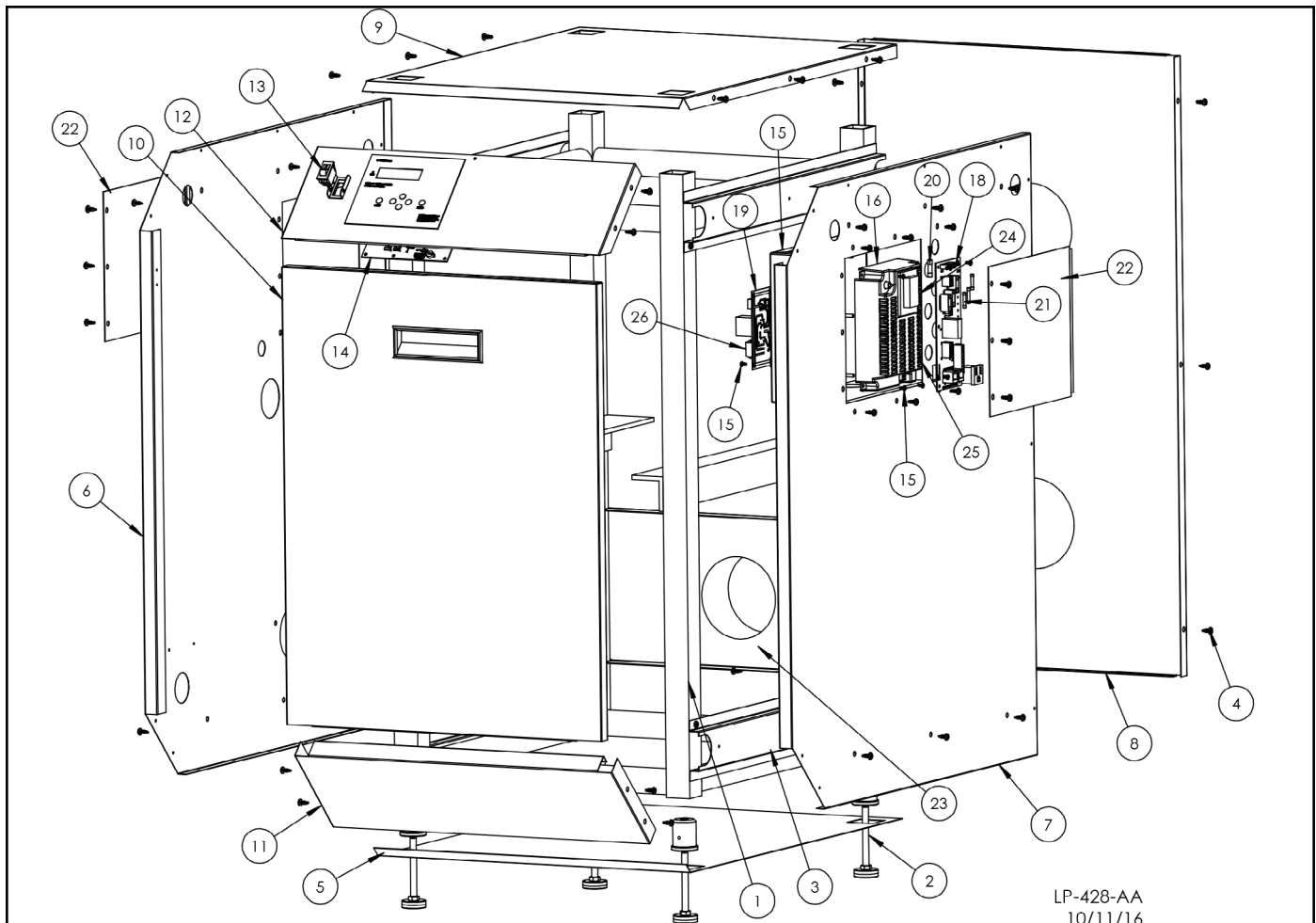

LP-428-AA
10/11/16

ITEM NO.	1000	1700	Description
1	7350P-345	7350P-346	MOD CON FRAME
2	7250P-317	7250P-317	LEVELING FOOT/MOUNT KIT
3	7250P-316	7250P-069	JACKET MOUNTING BRACKET
4	7350P-063	7350P-063	#10 x 1/2" SELF TAPPING SCREW
5	7350P-315	7350P-061	JACKET - BOTTOM (w/SCREWS)
6	7350P-313	7350P-057	JACKET - LEFT SIDE (w/SCREWS)
7	7350P-314	7350P-058	JACKET - RIGHT SIDE (w/SCREWS)
8	7350P-049	7350P-126	JACKET - REAR (w/SCREWS)
9	7350P-312	7350P-052	JACKET - TOP (w/SCREWS)
10	7350P-047	7350P-047	JACKET - FRONT
11	7350P-048	7350P-048	JACKET - LOWER FRONT (w/SCREWS)
12	7350P-748	7350P-748	JACKET - UPPER FRONT (INCLUDES PANEL, DISPLAY, SWITCH)
	7350P-146	7350P-146	JACKET - UPPER FRONT (PANEL ONLY)
13	7350P-228	7350P-228	POWER SWITCH
14	7450P-028	7450P-028	DISPLAY BOARD
15	7500P-115	7500P-115	SCREW PAN HEAD #6-32 x 1/4
16	7350P-042	7350P-042	ELECTRICAL BOX
17	7350P-008	7350P-008	926 CONTROL BOARD
18	7350P-070	7350P-070	FIELD CONNECTION BOARD
19	N/A	7250P-580	RELAY BOARD MODCON 1700
20	7250P-378	7250P-378	SIT CONTROLS 6.3 AMP FUSE
21	7350P-129	7350P-129	FUSE 3.15A MODCON
22	7350P-062	7350P-062	ELECTRICAL BOX/ACCESS PANEL COVER
23	7350P-103	7350P-104	AIR INLET BRACKET
24	7350P-085	7350P-086	120V WIRING HARNESS (LOCATION)
25	7350P-737	7350P-736	LOW VOLTAGE WIRING HARNESS (LOCATION)
26	N/A	7350P-012	BLOWER WIRING HARNESS (LOCATION)

Figure 37 - Cabinet Replacement Parts - All Models

**MODCON Boiler
Limited Warranty**

Ten year warranty to assure your complete satisfaction.

HTP warrants this boiler and its components to be free from defects in material and workmanship according to the following terms, conditions, and time periods. UNLESS OTHERWISE NOTED THESE WARRANTIES COMMENCE ON THE DATE OF INSTALLATION. This limited warranty is only available to the **original consumer purchaser** (hereinafter "Owner") of this boiler, and is non-transferable.

COVERAGE

A. During the first year after the date of installation, HTP warrants that it will repair or replace, at its option, any defective or malfunctioning component of the boiler that is found to have failed due to manufacturer's defect. Replacement components will be warranted for ninety (90) days. No other component of the boiler will be replaced after this period (with exception to the blower motor, which will have a limited warranty of three [3] years).

B. During the first through fifth year after the date of installation, should a defect or malfunction result in a leakage of water from the boiler due to defective material or workmanship, malfunction, or failure to comply with the above warranty, with such defect or malfunction having been verified by an authorized HTP representative, HTP will repair or replace, at its option, the defective or malfunctioning boiler. Replacements will be of the nearest comparable model available at the time of replacement. The replacement boiler will be warranted for the unexpired portion of the applicable warranty period of the original boiler.

C. During the sixth through tenth year after the date of installation, should a defect or malfunction result in a leakage of water from the boiler due to defective material or workmanship, malfunction, or failure to comply with the above warranty, with such defect or malfunction having been verified by an authorized HTP representative, HTP will repair or replace, at its option, the defective or malfunctioning boiler at a cost to the Owner equal to the following percentages of the manufacturer's list price in effect at the date of replacement:

Year of Claim	6	7	8	9	10
Percentage to be Paid by Purchaser	50 %	60 %	70%	80 %	90 %

Replacements will be of the nearest comparable model available at the time of replacement. The replacement boiler will be warranted for the unexpired portion of the applicable warranty period of the original boiler.

D. In the event of a leakage of water of a replacement boiler due to defective material or workmanship, malfunction, or failure to comply with the above warranty, HTP reserves the right to refund to the Owner the published wholesale price available at the date of manufacture of the original boiler.

E. If government regulations, industry certification, or similar standards require the replacement boiler or component(s) to have features not found in the defective boiler or component(s), the Owner will be charged the difference in price represented by those required features. If the Owner pays the price difference for those required features and/or to upgrade the size and/or other features available on a new replacement boiler or component(s), the Owner will also receive a complete new limited warranty for that replacement boiler or component(s).

F. If at the time of a request for service the Owner cannot provide a copy of the original sales receipt or the warranty registration, the warranty period for the boiler shall then be deemed to have commenced thirty (30) days after the date of manufacture of the boiler and NOT the date of installation of the boiler, and be covered

by the unexpired portion of the warranty detailed above.

G. This warranty extends only to boilers utilized in closed loop heating applications that have been properly installed based upon the manufacturer's installation instructions.

H. It is expressly agreed between HTP and the Owner that repair, replacement, or refund are the exclusive remedies of the Owner.

OWNER RESPONSIBILITIES

The Owner or Qualified Installer / Service Technician must:

1. Have a relief valve bearing the listing marks of the American Society of Mechanical Engineers (ASME) installed with the boiler assembly in accordance with federal, state, and local codes.
2. Maintain the boiler in accordance with the maintenance procedure listed in the manufacturer's provided instructions. Preventive maintenance can help avoid any unnecessary breakdown of the boiler and keep it running at optimum efficiency.
3. Maintain all related system components in good operating condition.
4. Check all condensate lines to confirm that all condensate drains properly from the boiler.
5. Use the boiler in a closed system with a properly sized and installed thermal expansion tank.
6. Use the boiler at water pressures not exceeding the working pressure shown on the rating plate.
7. Keep the boiler free of damaging scale deposits.
8. Make provisions so if the boiler or any component or connection thereto should leak, the resulting flow of water will not cause damage to the area in which it is installed.

WARRANTY EXCLUSIONS

This limited warranty will not cover:

1. Any boiler purchased from an unauthorized dealer.
2. Any boiler not installed by a qualified heating installer/service technician, or installations that do not conform to ANSI, CSA, and/or UL standards, as well as any applicable national or local building codes.
3. Service trips to teach the Owner how to install, use, maintain, or to bring the boiler installation into compliance with local building codes and regulations.
4. The workmanship of any installer. The manufacturer disclaims and does not assume any liability of any nature caused by improper installation, repair, or maintenance.
5. Electricity or fuel costs, or increased or unrealized savings for same, for any reason whatsoever.
6. Any water damage arising, directly or indirectly, from any defect in the boiler or component part(s) or from its use.
7. Any incidental, consequential, special, or contingent damages or expenses arising, directly or indirectly, from any defect in the boiler or the use of the boiler.
8. Failure to locate the boiler in an area where leakage of the boiler or water line connections and the relief valve will not result in damage to the area adjacent to the boiler or lower floors of the structure, as well as failure to install the boiler with properly designed containment measures.
9. Any failed components of the system not manufactured by HTP as part of the boiler.
10. Boilers repaired or altered without the prior written approval of HTP.
11. Damages, malfunctions, or failures resulting from failure to install the boiler in accordance with applicable building codes/ordinances or good plumbing and electrical trade practices.
12. Damages, malfunctions, or failures resulting from improper installation, failure to operate the boiler at firing rates or pressures not exceeding those on the rating plate, or failure to operate and maintain the boiler in accordance with the manufacturer's provided instructions.
13. Failure to operate the boiler in a closed system with a properly

sized and installed thermal expansion tank.

14. Failure or performance problems caused by improper sizing of the boiler, expansion device, piping, or the gas supply line, the venting connection, combustion air openings, electric service voltage, wiring or fusing.

15. Damages, malfunctions, or failures caused by improper conversion from natural gas to LP gas or LP gas to natural gas.

16. Damages, malfunctions, or failures caused by operating the boiler with modified, altered, or unapproved components, or any component / attachment not supplied by HTP.

17. Damages, malfunctions, or failures caused by abuse, accident, fire, flood, freeze, lightning, electrochemical reaction, acts of God and the like.

18. Failures (leaks) caused by operating the boiler in a corrosive or contaminated atmosphere.

19. Damages, malfunctions, or failures caused by operating an empty or partially empty boiler ("dry firing"), or failures caused by operating the boiler when it is not supplied with water, free to circulate at all times.

20. Any damage or failure of the boiler due to the accumulation of solid materials or lime deposits.

21. Any damage or failure resulting from improper water chemistry. WATER CHEMISTRY REQUIREMENTS – Water pH between 6.5 and 8.5. Hardness less than 7 grains (120 mg/L). Chloride concentration less than 100 ppm (mg/L). TDS less than 500 ppm (mg/L).

22. Any damages, malfunctions, or failures resulting from the use of dielectric unions.

23. Boilers replaced for cosmetic reasons.

24. Components of the boiler that are not defective, but must be replaced during the warranty period as a result of reasonable wear and tear.

25. Components of the boiler that are subject to warranties, if any, given by their manufacturers; HTP does not adopt these warranties.

26. Damages, malfunctions, or failures resulting from the use of any attachment(s) not supplied by HTP.

27. Boilers installed outside the fifty states (and the District of Columbia) of the United States of America and Canada.

28. Boilers moved from the original installation location.

29. Boilers that have had their rating labels removed.

PROCEDURES FOR WARRANTY SERVICE REQUESTS

Any claim for warranty assistance must be made immediately upon finding the issue. First, please consult the HTP Warranty Wizard (<http://www.htproducts.com/Warranty-Wizard.html>) to check warranty eligibility. You may also contact HTP Technical Support at 1-800-323-9651 for questions or assistance. Warranty coverage requires review and approval of the issue with HTP Technical Support or through the Warranty Wizard prior to a full unit replacement. Any claim for warranty reimbursement will be rejected if prior approval from HTP is not obtained in advance of a full unit replacement. Final determination will be made as part of the warranty claim process.

When submitting a warranty claim the following items are required:

1. Proof of purchase or installation of the product – Typically a copy of the invoice from the installing contractor, the receipt of the purchase of the product, or an original certificate of occupancy for a new home.

2. Clear pictures (or video) of the following:

- a. Serial number tag (sticker)
- b. The product
- c. The product issue / failure whenever possible
- d. A picture of the piping near the product
- e. For gas fired products, a picture of the venting, including how it exits the building

All claims will be reviewed by HTP within three (3) business days. If additional information is required and requested by the HTP Claims Department you will have thirty (30) days to provide it. When all

requested information is provided HTP will respond within three (3) business days. The claim will be automatically closed if requested information is not provided within thirty (30) days. Claims will not be reopened without HTP Warranty Supervisor approval.

During the claims process a product that must be replaced will be given a designation of either a) field scrap, or b) return to HTP. If the product must be returned to HTP, the returned product must arrive at HTP within thirty (30) days of the date of our request to return the product. After receipt of the returned product HTP may require as many as thirty (30) additional days for product testing. **NOTE: Any components or heaters returned to HTP for warranty analysis will become the property of HTP and will not be returned, even if credit is denied.**

If you have questions about the coverage of this warranty, please contact HTP at the following address or phone number: HTP, 272 Duchaine Blvd., New Bedford, MA, 02745, Attention: Warranty Service Department, 1(800) 323-9651.

SERVICE, LABOR AND SHIPPING COSTS

Except when specifically prohibited by the applicable state law, the Owner, and not the Manufacturer, shall be liable for and shall pay for all charges for labor or other expenses incurred in the removal, repair, or replacement of the boiler or any component part(s) claimed to be defective or any expense incurred to remedy any defect in the product. Such charges include, but are not necessarily limited to:

1. All freight, shipping, handling, and delivery costs of forwarding a new boiler or replacement part(s) to the owner.
2. All costs necessary or incidental in removing the defective boiler or component part(s) and installing a new boiler or replacement part(s).
3. All administrative fees incurred by the Owner, as well as material required to complete, and/or permits required for, installation of a new boiler or replacement part(s), and
4. All costs necessary or incidental in returning the defective boiler or component part(s) to a location designated by the manufacturer.

LIMITATIONS OF THIS HTP WARRANTY AND REMEDIES

THE FOREGOING WARRANTIES ARE EXCLUSIVE AND ARE GIVEN AND ACCEPTED TO THE FURTHEST EXTENT UNDER APPLICABLE LAW IN LIEU OF ANY AND ALL OTHER WARRANTIES, EXPRESS OR IMPLIED, INCLUDING WITHOUT LIMITATION THE IMPLIED WARRANTIES OF MERCHANTABILITY AND FITNESS FOR A PARTICULAR PURPOSE AND ANY OBLIGATION, LIABILITY, RIGHT, CLAIM OR REMEDY IN CONTRACT OR TORT, WHETHER OR NOT ARISING FROM HTP'S NEGLIGENCE, ACTUAL OR IMPUTED. THE REMEDIES OF THE OWNER SHALL BE LIMITED TO THOSE PROVIDED HEREIN TO THE EXCLUSION OF ANY OTHER REMEDIES INCLUDING WITHOUT LIMITATION, INCIDENTAL OR CONSEQUENTIAL DAMAGES, SAID INCIDENTAL AND CONSEQUENTIAL DAMAGES INCLUDING, BUT NOT LIMITED TO, PROPERTY DAMAGE, LOST PROFIT OR DAMAGES ALLEGED TO HAVE BEEN CAUSED BY ANY FAILURE OF HTP TO MEET ANY OBLIGATION UNDER THIS AGREEMENT INCLUDING THE OBLIGATION TO REPAIR AND REPLACE SET FORTH ABOVE. NO AGREEMENT VARYING OR EXTENDING THE FOREGOING WARRANTIES, REMEDIES OR THIS LIMITATION WILL BE BINDING UPON HTP. UNLESS IN WRITING AND SIGNED BY A DULY AUTHORIZED OFFICER OF HTP. THE WARRANTIES STATED HEREIN ARE NOT TRANSFERABLE AND SHALL BE FOR THE BENEFIT OF THE ORIGINAL OWNER ONLY.

NO OTHER EXPRESS WARRANTIES

This warranty gives the Owner specific legal rights. The Owner may also have other rights that vary from state to state. Some states do not allow the exclusion or limitation of incidental or consequential damages so this limitation or exclusion may not apply to the Owner. These are the only written warranties applicable to this boiler manufactured and sold by HTP. HTP neither assumes nor authorizes anyone to assume for it any other obligation or liability in connection with said boilers.

HTP reserves the right to change specifications or discontinue models without notice.

Customer Installation Record Form	
The following form should be completed by the qualified installer / service technician for you to keep as a record of the installation in case of a warranty claim. After reading the important notes at the bottom of the page, please also sign this document.	
Customer's Name	
Date of Installation	
Installation Address	
Product Name / Serial Number(s)	
Comments	
Installer's Code / Name	
Installers Phone Number	
Signed by Installer	
Signed by Customer	
Installation Notes	

IMPORTANT

Customer: Please only sign after the qualified installer / service technician has fully reviewed the installation, safety, proper operation, and maintenance of the system. If the system has any problems please call the qualified installer / service technician. If you are unable to make contact, please call your sales representative.

Distributor / Dealer: Please insert contact details.