

- Navien **Ready-Link® Rack V2** system can be used to mount a single or multiple water heater or boiler units that are connected to a cascade system

- This accessory is **compatible** with the following Navien models:

**NPE-A\*** Series Tankless Water Heaters

**NPE-S\*** Series Tankless Water Heaters

**NCB-E** Series Combination Boilers

**NHB** Series Heating Boilers

**NFB-175/200** Fire Tube Heating Boilers

*\* Rack systems with NPE Series models are rated for both **INDOOR** and **OUTDOOR** installations*

- Recommended** for systems that are located in tight spacing or in areas without enough available wall spacing.

- Designed** to hold water heater and boiler units as well as common water and gas piping









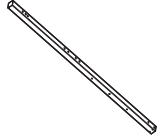

- Dimensions:** see below

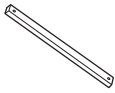
- Weight:** 42.0 lbs (19.0 kg) per **BASE** Kit, 24.0 lbs (10.9 kg) per **ADD-ON** Kit

- Navien Part Number(s):** **GFFM-KDIZUS-003** (**BASE** for single or 2 units back-to-back)

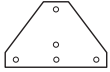
**GFFM-KDIZUS-004** (**ADD-ON** extension kit for 2+ units in-line or 3+ units back-to-back)

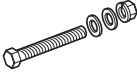
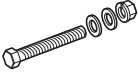
- The Navien **Ready-Link® Rack V2** includes the following items:

					
<b>Installation Guide</b> 1 EA	<b>Post bar 64.4"</b> * Single kit: 2 EA ** Extension kit: 1 EA	<b>Fixed bar 17.7"</b> * Single kit: 2 EA ** Extension kit: 2 EA	<b>Base frame 23.8"</b> * Single kit: 2 EA ** Extension kit: 1 EA	<b>Fixed bracket (under)</b> * Single kit: 4 EA ** Extension kit: 2 EA	<b>Fixed bracket (middle)</b> * Single kit: 4 EA ** Extension kit: 4 EA
					
<b>Fixed bracket (upper)</b> * Single kit: 2 EA ** Extension kit: 2 EA	<b>Reinforcement plate</b> * Single kit: 4 EA ** Extension kit: 2 EA	<b>Tapping screw 5X12 (stainless steel)†</b> * Single kit: 20 EA ** Extension kit: 12 EA	<b>M10 bolt set (3 in, stainless steel)</b> * Single kit: 22 EA ** Extension kit: 13 EA	<b>M10 bolt set (2.8 in, stainless steel)</b> * Single kit: 3EA ** Extension kit: 3EA	<b>5/32 in or 4mm Allen wrench</b> 1EA

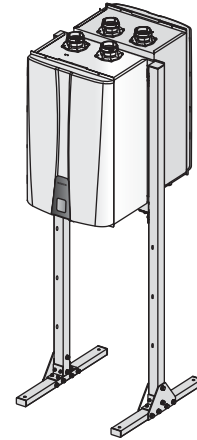

**NEW! Compact Design with In-line or Back-to-Back Setup**

## Dimensions

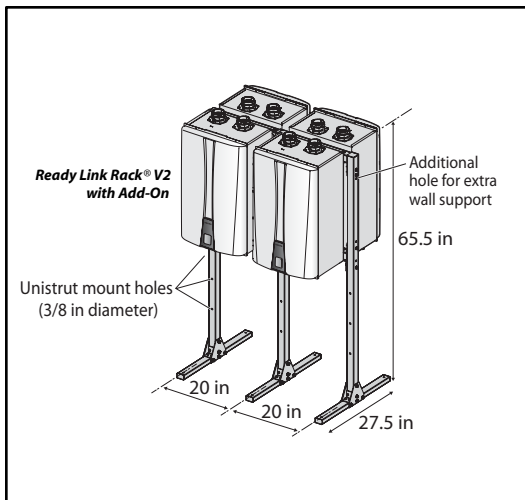

## Installation Examples

