

MAGNA3

Installation and operating instructions



Original installation and operating instructions.

CONTENTS

	Page		Page
1. Limited warranty	3	15. Selection of control mode	35
2. Symbols used in this document	3	16. Fault finding	37
3. General information	4	16.1 Grundfos Eye operating indications	37
3.1 Applications	4	16.2 Signalling communication with remote control	37
3.2 Pumped liquids	4	16.3 Fault finding	38
3.3 Operating conditions	5	17. Sensor	39
3.4 Frost protection	5	17.1 Sensor specifications	39
3.5 Insulating shells	5	18. Accessories	40
3.6 Non-return valve	5	18.1 Grundfos GO Remote	40
3.7 Nameplate	6	18.2 Communication	40
3.8 Radio communication	7	18.3 Fitting the CIM module	43
3.9 Tools	7	19. Technical data	44
4. Mechanical installation	7	20. Disposal	44
4.1 Installing the pump	7		
4.2 Positioning	8		
4.3 Control box positions	8		
4.4 Pump head position	8		
4.5 Changing the control box position	9		
5. Electrical installation	10		
5.1 Supply voltage	11		
5.2 Connection to the power supply (models 40-XX, 50-XX, 65-XX, 80-XX, 100-XX)	11		
5.3 Connection to the power supply (models 32-XX)	12		
5.4 Connection diagram	13		
5.5 Input/output communication	15		
5.6 Analog input for external sensor	17		
5.7 Electrical connection for external sensor	18		
5.8 Priority of settings	18		
6. First start-up	19		
7. Settings	20		
7.1 Overview of settings	20		
8. Menu overview	21		
9. Control panel	22		
10. Menu structure	22		
11. "Home" menu	22		
12. "Status" menu	23		
13. "Settings" menu	23		
13.1 Setpoint	23		
13.2 Operating mode	24		
13.3 Control mode	24		
13.4 FLOWLIMIT	28		
13.5 Automatic Night Setback	28		
13.6 Relay outputs	29		
13.7 Setpoint influence	29		
13.8 Bus communication	30		
13.9 General settings	30		
14. "Assist" menu	34		
14.1 Assisted pump setup	34		
14.2 Setting of date and time	34		
14.3 Multi-pump setup	34		
14.4 Setup, analog input	34		
14.5 Description of control mode	34		
14.6 Assisted fault advice	34		
14.7 Wireless GENIair	34		
14.8 Multi-pump function	34		

**Warning**

Prior to installation, read these installation and operating instructions. Installation and operation must comply with local regulations and accepted codes of good practice.

**Warning**

The use of this product requires experience with and knowledge of the product.

Persons with reduced physical, sensory or mental capabilities must not use this product, unless they are under supervision or have been instructed in the use of the product by a person responsible for their safety.

Children must not use or play with this product.

1. Limited warranty

Products manufactured by GRUNDFOS PUMPS CORPORATION (Grundfos) are warranted to the original user only to be free of defects in material and workmanship for a period of 24 months from date of installation, but not more than 30 months from date of manufacture. Grundfos' liability under this warranty shall be limited to repairing or replacing at Grundfos' option, without charge, F.O.B. Grundfos' factory or authorized service station, any product of Grundfos' manufacture. Grundfos will not be liable for any costs of removal, installation, transportation, or any other charges which may arise in connection with a warranty claim. Products which are sold but not manufactured by Grundfos are subject to the warranty provided by the manufacturer of said products and not by Grundfos' warranty. Grundfos will not be liable for damage or wear to products caused by abnormal operating conditions, accident, abuse, misuse, unauthorized alteration or repair, or if the product was not installed in accordance with Grundfos' printed installation and operating instructions.

To obtain service under this warranty, the defective product must be returned to the distributor or dealer of Grundfos' products from which it was purchased together with proof of purchase and installation date, failure date, and supporting installation data. Unless otherwise provided, the distributor or dealer will contact Grundfos or an authorized service station for instructions. Any defective product to be returned to Grundfos or a service station must be sent freight prepaid; documentation supporting the warranty claim and/or a Return Material Authorization must be included if so instructed.

GRUNDFOS WILL NOT BE LIABLE FOR ANY INCIDENTAL OR CONSEQUENTIAL DAMAGES, LOSSES, OR EXPENSES ARISING FROM INSTALLATION, USE, OR ANY OTHER CAUSES. THERE ARE NO EXPRESS OR IMPLIED WARRANTIES, INCLUDING MERCHANTABILITY OR FITNESS FOR A PARTICULAR PURPOSE, WHICH EXTEND BEYOND THOSE WARRANTIES DESCRIBED OR REFERRED TO ABOVE.

Some jurisdictions do not allow the exclusion or limitation of incidental or consequential damages and some jurisdictions do not allow limit actions on how long implied warranties may last. Therefore, the above limitations or exclusions may not apply to you. This warranty gives you specific legal rights and you may also have other rights which vary from jurisdiction to jurisdiction.

2. Symbols used in this document



Warning

If these safety instructions are not observed, it may result in personal injury.



Warning

If these instructions are not observed, it may lead to electric shock with consequent risk of serious personal injury or death.



Warning

The surface of the product may be so hot that it may cause burns or personal injury.



Warning

Risk of dropping objects which may cause personal injury.



Warning

Escaping vapor involves the risk of personal injury.

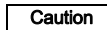

Caution

If these safety instructions are not observed, it may result in malfunction or damage to the equipment.

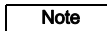

Note

Notes or instructions that make the job easier and ensure safe operation.

3. General information



The Grundfos MAGNA3 is a complete range of circulator pumps with integrated controller enabling adjustment of pump performance to the actual system requirements. In many systems, this will reduce the power consumption considerably, reduce noise from thermostatic radiator valves and similar fittings and improve the control of the system.

The desired head can be set on the pump control panel.

3.1 Applications

The Grundfos MAGNA3 is designed for circulating liquids in the following systems:

- heating systems
- domestic hot-water systems
- air-conditioning and cooling systems.

The pump can also be used in the following systems:

- ground source heat pump systems
- solar-heating systems.

3.2 Pumped liquids

The pump is suitable for thin, clean, non-aggressive and non-explosive liquids, not containing solid particles or fibers that may attack the pump mechanically or chemically.

In heating systems, the water should meet the requirements of accepted standards on water quality in heating systems.

In domestic hot-water systems, we recommend to use MAGNA3 pumps only for water with a degree of hardness lower than approx. 14 °dH.

In domestic hot-water systems, we recommend to keep the liquid temperature below 150 °F (+65 °C) to eliminate the risk of lime precipitation.



Warning

Do not use the pump for flammable liquids, such as diesel oil and gasoline.



Warning

Do not use the pump for aggressive liquids, such as acids and sea water.



Max. 95 % RH
Enclosure Type 2



TM05 2857 0612

Fig. 1 Pumped liquids

3.2.1 Glycol

The pump can be used for pumping water/glycol mixtures up to 50 %.

Example of a water/ethylene glycol mixture:

Maximum viscosity: 50 cSt ~ 50 % water / 50 % ethylene glycol mixture at +14 °F (-10 °C).

The pump has a power-limiting function that protects against overload.

The pumping of glycol mixtures will affect the max. curve and reduce the performance, depending on the water/ethylene glycol mixture and the liquid temperature.

To prevent the ethylene glycol mixture from degrading, avoid temperatures exceeding the rated liquid temperature and minimize the operating time at high temperatures.

It is important to clean and flush the system before the ethylene glycol mixture is added.

To prevent corrosion or lime precipitation, check and maintain the ethylene glycol mixture regularly. If further dilution of the supplied ethylene glycol is required, follow the glycol supplier's instructions.

Note

Additives with a density and/or kinematic viscosity higher than those/that of water will reduce the hydraulic performance.

3.3 Operating conditions

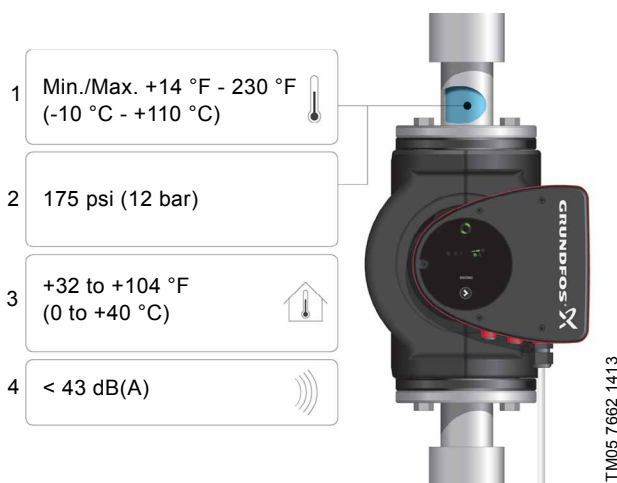

Fig. 2 Operating conditions

3.3.1 Liquid temperature

See fig. 2, pos. 1.

Continuously: +14 °F to +230 °F (-10 °C to +110 °C).

Domestic hot-water systems:

- Up to +150 °F (+65 °C).

3.3.2 System pressure

See fig. 2, pos. 2.

The maximum permissible system pressure is stated on the pump nameplate.

3.3.3 Ambient temperature

See fig. 2, pos. 3.

+32 °F to +104 °F (0 °C to +40 °C).

The control box is air-cooled. Therefore, it is important that the maximum permissible ambient temperature is not exceeded during operation.

During transport: -40 °F to +158 °F (-40 °C to +70 °C).

3.3.4 Sound pressure level

See fig. 2, pos. 4.

The sound pressure level of the pump is lower than 43 dB(A).

3.3.5 Approvals

- Conforms to ANSI/UL Standard 778.
- Certified to CAN/CSA Standard C22.2 No. 108.
- The protective earth (ground) symbol \oplus identifies any terminal which is intended for connection to an external conductor for protection against electric shock in case of a fault, or the terminal of a protective earth (ground) electrode.

3.4 Frost protection

Caution

If the pump is not used during periods of frost, necessary steps must be taken to prevent frost bursts.

Note

Additives with a density and/or kinematic viscosity higher than those/that of water will reduce the hydraulic performance.

3.5 Insulating shells

Insulating shells are available for single-head pumps only.

Note

Limit the heat loss from the pump housing and pipework.

The heat loss from the pump and pipework can be reduced by insulating the pump housing and the pipework. See fig. 3 and fig. 13.

- Insulating shells for pumps in heating systems are supplied with the pump; see fig. 3.
- For pumps in air-conditioning and cooling systems (down to +14 ° (-10 °C)) it is required to apply a silicon sealant to the internal contours of the shell in order to eliminate any air gaps and prevent condensation between the insulation shell and pump housing. Alternatively, the pump can also be insulated manually in accordance with standard insulating requirements for heating and cooling systems (fig. 13).

The fitting of insulating shells will increase the pump dimensions.



Fig. 3 Fitting insulating shells to the pump

Caution

Do not insulate the control box or cover the control panel.

3.6 Non-return valve

If a non-return valve is fitted in the pipe system (fig. 4), it must be ensured that the set minimum discharge pressure of the pump is always higher than the closing pressure of the valve. This is especially important in proportional-pressure control mode (reduced head at low flow). The closing pressure of a single non-return valve is accounted for in the pump settings as the minimum head delivered is 5 ft (1.5 m).

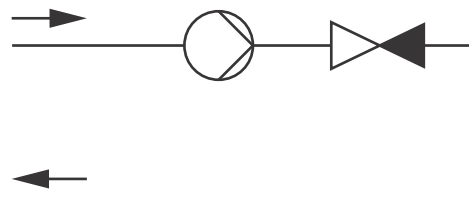

Fig. 4 Non-return valve

TM05 7662 1413

TM05 2859 0612

TM05 3055 0912

3.7 Nameplate

The pump nameplate provides the following information:

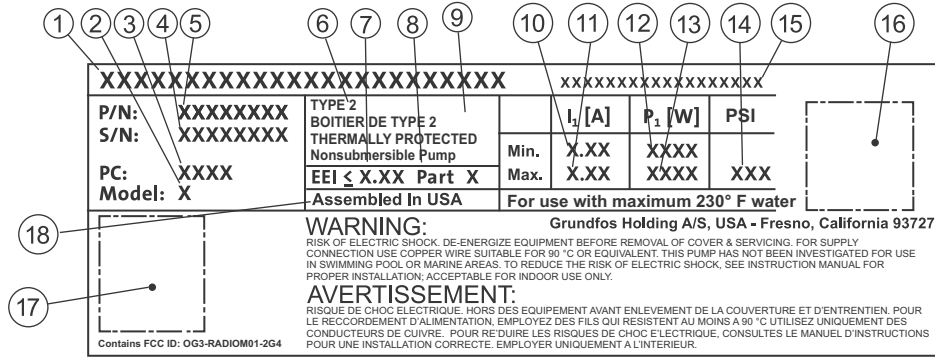

Fig. 5 Example of nameplate

Pos.	Description
1	Product name
2	Model
3	Production code (year and week)
4	Serial number
5	Product number
6	Enclosure type
7	Energy Efficiency Index (EEI)
8	Part (according to EEI)
9	TF-class
10	Minimum current [A]
11	Maximum current [A]
12	Minimum power [W]
13	Maximum power [W]
14	Maximum pressure
15	Voltage [V] and frequency [Hz]
16	QR (Quick Response) code
17	Approvals (nameplate)
18	Assembled in USA

3.8 Radio communication

The wireless radio in this product is class B.

Intended use

This product incorporates a radio for remote control.

The product can communicate with Grundfos Go Remote and with other MAGNA3 pumps of the same type via the built-in radio.

Only Grundfos-approved external antennae may be connected to this product, and only by a Grundfos-approved installer.

3.9 Tools

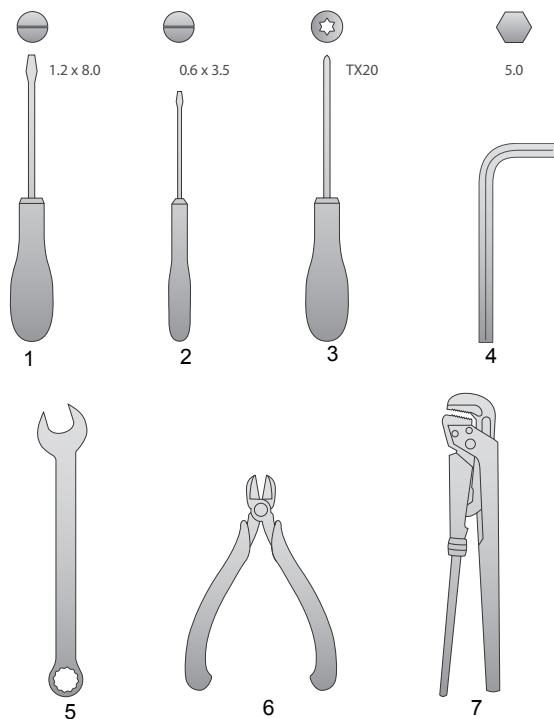

Fig. 6 Recommended tools

Pos.	Tool	Size
1	Screwdriver, straight slot	1.2 x 8.0 mm
2	Screwdriver, straight slot	0.6 x 3.5 mm
3	Screwdriver, torx bit	TX20
4	Hexagon key	5.0 mm
5	Open-end wrench	Depending on flange bolt size
6	Wire cutter	
7	Pipe wrench	

4. Mechanical installation



4.1 Installing the pump

MAGNA3 is designed for indoor installation.

The pump must be installed in such a way that it is not stressed by the pipework.

The pump may be suspended direct in the pipes, provided that the pipework can support the pump.

Twin-head pumps are prepared for installation on a mounting bracket or base plate.

To ensure adequate cooling of motor and electronics, the following must be observed:

- Position the pump in such a way that sufficient cooling is ensured.
- The temperature of the ambient air must not exceed +104 °F (+40 °C).



Warning

Observe local regulations setting limits for manual lifting or handling.

Step	Action	Illustration
1	Arrows on the pump housing indicate the liquid flow direction through the pump. The liquid flow direction can be horizontal or vertical, depending on the control box position.	TM05 2862 0612
2	Close the isolating valves and make sure that the system is not pressurized during the installation of the pump.	TM05 2863 0612
3	Mount the pump with gaskets in the pipework.	TM05 2864 0612
4	Fit bolts and nuts. Use the right size of bolts according to system pressure.	TM05 2865 0612

4.2 Positioning

Always install the pump with horizontal motor shaft.

- Pump installed correctly in a vertical pipe. See fig. 7, pos. A.
- Pump installed correctly in a horizontal pipe. See fig. 7, pos. B.
- Do not install the pump with vertical motor shaft. See fig. 7, pos. C and D.

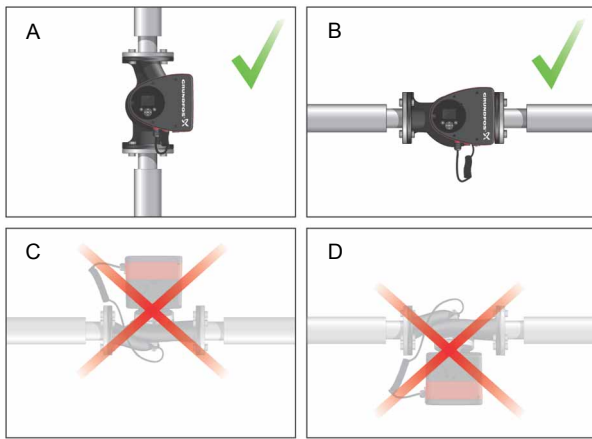

TM05 2866 0712

Fig. 7 Pump installed with horizontal motor shaft

4.3 Control box positions

To ensure adequate cooling, the control box must be in horizontal position with the Grundfos logo in vertical position. See fig. 8.

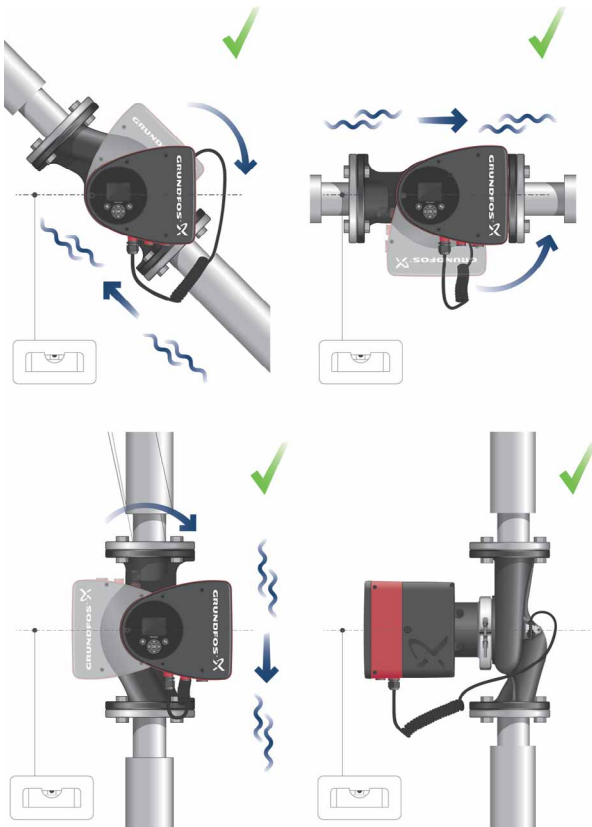

TM05 2915 0612

Fig. 8 Pump with control box in horizontal position

If the pump head is removed before the pump is installed in the pipework, pay special attention when fitting the pump head to the pump housing:

1. Gently lower the pump head with rotor shaft and impeller into the pump housing.
2. Make sure that the contact face of the pump housing and that of the pump head are in contact before the clamp is tightened. See fig. 9.

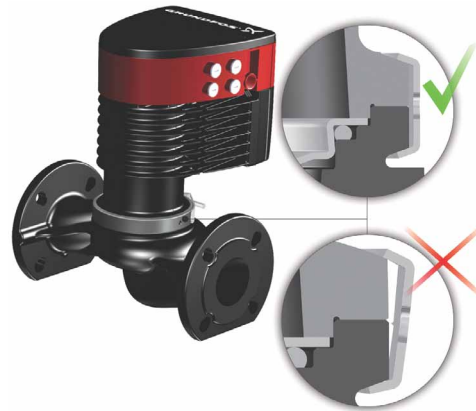

TM05 5837 4112

Fig. 9 Fitting the pump head to the pump housing

4.4 Pump head position

If the pump head is removed before the pump is installed in the pipework, pay special attention when fitting the pump head to the pump housing:

3. Visually check that the floating ring in the sealing system is centered. See figs. 10 and 11.
4. Gently lower the pump head with rotor shaft and impeller into the pump housing.
5. Make sure that the contact face of the pump housing and that of the pump head are in contact before the clamp is tightened. See fig. 12.



TM05 6650 5012

Fig. 10 Correctly centered sealing system



Fig. 11 Incorrectly centered sealing system

Caution

Observe the position of the clamp before the clamp is tightened. Incorrect position of the clamp will cause leakage from the pump and damage the hydraulic parts in the pump head. See fig. 12.

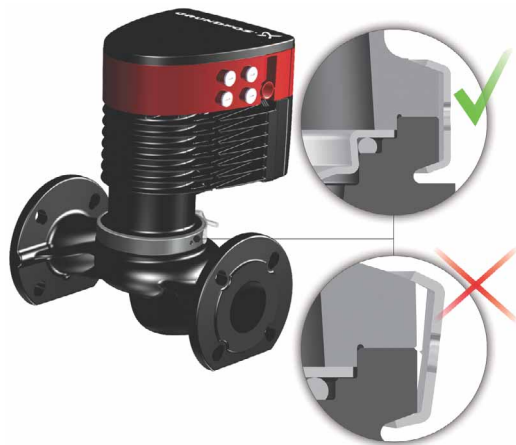





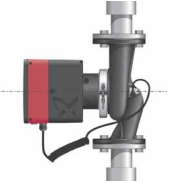

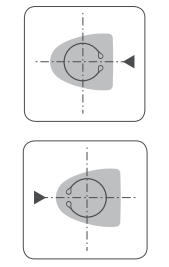

Fig. 12 Fitting the pump head to the pump housing



4.5 Changing the control box position

-  **Warning**
The warning symbol on the clamp holding the pump head and pump housing together indicates that there is a risk of personal injury. See specific warnings below.
-  **Warning**
When loosening the clamp, do not drop the pump head.
-  **Warning**
Risk of escaping vapor.

TM05 6651 5012

Step	Action	Illustration
1	Loosen the screw in the clamp holding the pump head and pump housing together. Warning: If the screw is loosened too much, the pump head will be completely disconnected from the pump housing.	 TM05 2867 0612
2	Carefully rotate the pump head to the desired position. If the pump head is stuck, loosen it with a light blow of a rubber mallet.	 TM05 2868 0612
3	Position the control box in horizontal position so that the Grundfos logo is in vertical position. The motor shaft must be horizontal.	 TM05 2869 0612
4	Due to the drain hole in the stator housing, position the gap of the clamp as shown in step 4a, 4b, 4c or 4d.	 TM05 2870 0612
4a	Single-head pump. Position the clamp so that the gap points towards the arrow. It can be in position 3 or 9 o'clock.	 TM05 2918 0612 - TM05 2871 0612

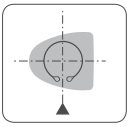
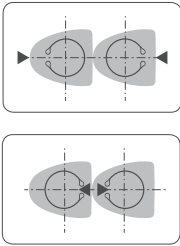
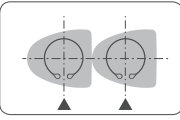
TM05 5837 4112

Step	Action	Illustration
4b	<p>Single-head pump. Note: The gap of the clamp can also be in position 6 o'clock for the following pump sizes:</p> <ul style="list-style-type: none"> • MAGNA3 65-XX • MAGNA3 80-XX • MAGNA3 100-XX. 	
4c	<p>Twin-head pump. Position the clamps so that the gaps point towards the arrows. They can be in position 3 or 9 o'clock.</p>	
4d	<p>Twin-head pump. Note: The gap of the clamp can also be in position 6 o'clock for the following pump sizes:</p> <ul style="list-style-type: none"> • MAGNA3 65-XX • MAGNA3 80-XX • MAGNA3 100-XX. 	
6	<p>Fit and tighten the screw holding the clamp to minimum 6 ± 0.7 ft-lbs (8 ± 1 Nm).</p>	
7	<p>Fit the insulating shells. Note: For air conditioning and cooling systems a silicone sealant must be applied inside the insulation shell to eliminate all air gaps and prevent condensation between the pump housing and insulation shell. Alternatively, the pump may be insulated manually in accordance with standard insulation practices for cooling applications.</p>	

Caution *If insulating the pump manually, do not insulate the control box or cover the control panel.*



Fig. 13 Insulation of pump housing and pipework

5. Electrical installation



Carry out the electrical connection and protection according to local regulations.

Check that the supply voltage and frequency correspond to the values stated on the nameplate.



Warning
Never make any connections in the pump control box unless the power supply has been switched off for at least 5 minutes.

Warning
The pump must be connected to an external mains switch with a contact separation of at least 1/8 inch (3 mm) in each pole.



Warning
The ground terminal of the pump must be connected to ground. Grounding or neutralization can be used for protection against indirect contact.

Warning
If the pump is connected to an electric installation where a Ground Fault Circuit Interrupter (GFCI) is used as additional protection, this circuit interrupter must trip out when ground fault currents with DC content (pulsating DC) occur.

- If rigid conduit is to be used, the hub must be connected to the conduit system before it is connected to the terminal box of the pump.
- The pump must be connected to an external mains switch.
- The pump requires no external motor protection.
- The motor incorporates thermal protection against slow overloading and blocking.
- When switched on via the power supply, the pump will start pumping after approx. 5 seconds.

Note *The number of starts and stops via the power supply must not exceed four times per hour.*

TM05 5549 3812

5.1 Supply voltage

1 x 115 V ± 10 %, 50/60 Hz, PE.

1 x 208-230 V ± 10 %, 50/60 Hz, PE.

See pump nameplate for rated supply voltage

The voltage tolerances are intended for mains voltage variations. They should not be used for running pumps at other voltages than those stated on the nameplate.

5.2 Connection to the power supply (models 40-XX, 50-XX, 65-XX, 80-XX, 100-XX)

Step	Action	Illustration
1	Remove the front cover from the control box.	
2	Locate the power supply plug and conduit adapter in the box supplied with the pump.	
3	Connect the conduit adapter to the control box.	
4	Pull the power supply cable through the conduit adapter.	
5	Strip the cable conductors as illustrated.	

Step	Action	Illustration
6	Connect the cable conductors to the power supply plug. L - L or L1 Ground - Ground N - N or L2	
7	Insert the power supply plug into the male plug in the pump control box.	
8	Tighten the conduit adapter. Refit the front cover.	

5.3 Connection to the power supply (models 32-XX)

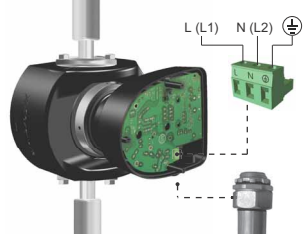
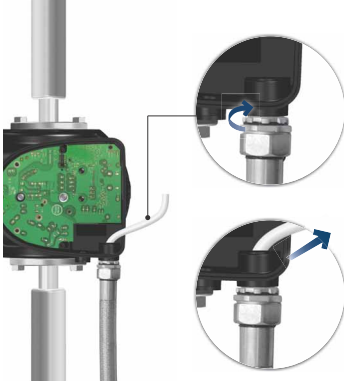
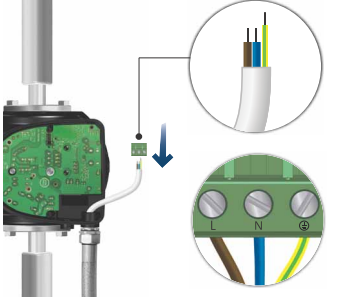
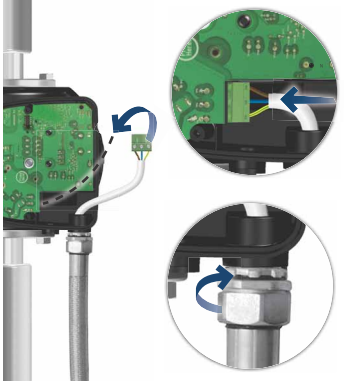
Step	Action	Illustration
1	Remove two screws. Remove the front cover from the control box and access the power connection.	 TM06 1102 1614
2	Locate the power plug inside.	 TM06 1103 1614
3	Connect the conduit to the control box. Pull the power supply cable through the conduit.	 TM06 1104 1614
5	Strip the cable as illustrated. Connect the cable conductors to the power supply plug. L - L or L1 Ground - Ground N - N or L2	 TM06 1105 1614
6	Insert the power plug into its mating connector. Tighten the conduit.	 TM06 1106 1614

Step	Action	Illustration
7	Refit the front cover.	 TM06 1107 1614

5.4 Connection diagram

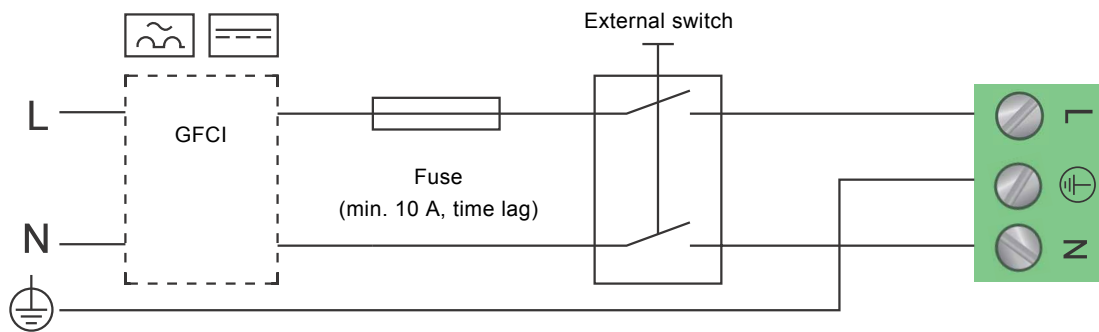

Fig. 14 Example of typical connection, 1 x 230 V ± 10 %, 50/60 Hz

TM03 2397 0312

Note All cables used must be connected in accordance with local regulations.

5.4.1 Connection to external controllers

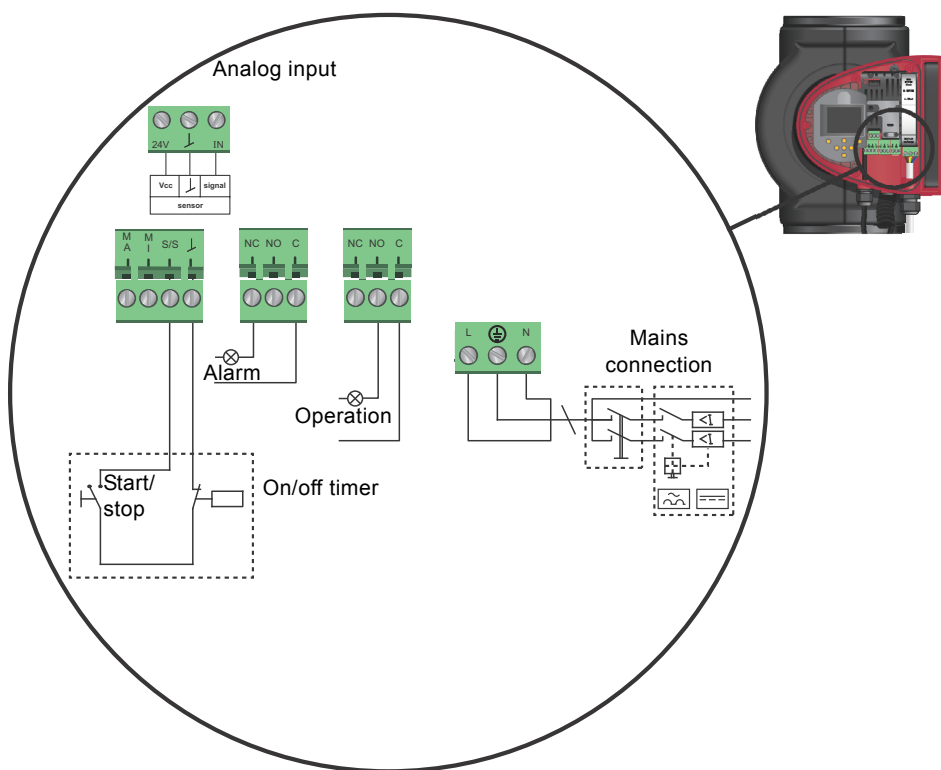

Fig. 15 Example of connections in the control box

TM05 2673 3812



Warning
Wires connected to supply terminals, outputs NC, NO, C and start/stop input must be separated from each other and from the supply by reinforced insulation.

Concerning demands on signal wires and signal transmitters, see section 19. [Technical data](#).

Use screened cables for external on/off switch, digital input, sensor and setpoint signals.

Note All cables used must be heat-resistant up to +185 °F (+85 °C).

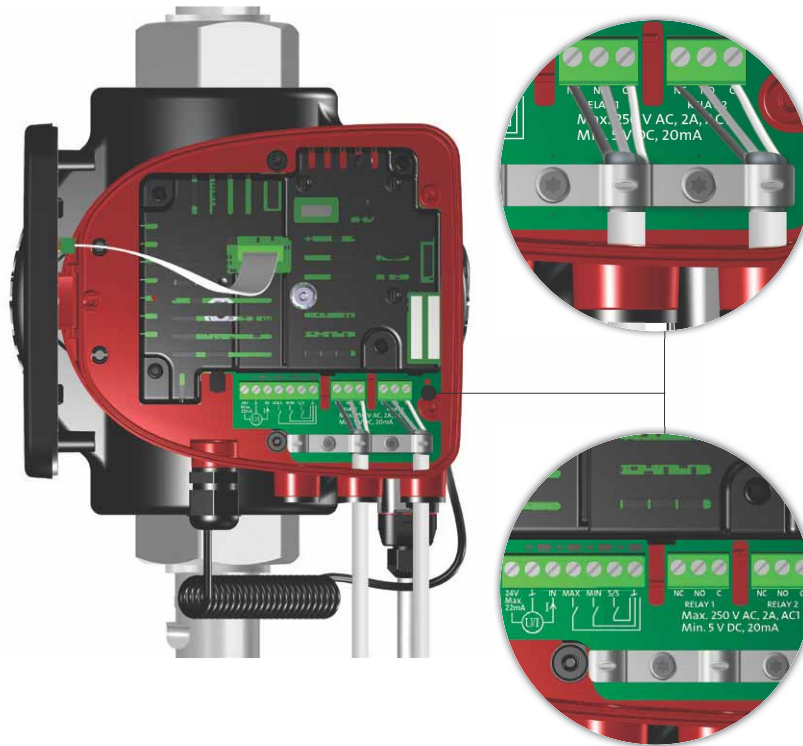

Fig. 16 Wiring diagram, 32-XX versions

The connection terminals of 32-XX versions differ from those of terminal-connected versions, but they have the same function and connection options.

Use screened cables for external on/off switch, digital input, sensor and setpoint signals.

Connect screened cables to the ground connection as follows:

- Terminal-connected versions:
Connect the cable screen to ground via the digital-input terminal (earth).
- Plug-connected versions:
Connect the cable screen to ground via cable clamp.



Warning

Wires connected to supply terminals, outputs NC, NO, C and start/stop input must be separated from each other and from the supply by reinforced insulation.

All cables used must be heat-resistant up to +85 °C.

Note

All cables used must be installed in accordance with EN 60204-1 and EN 50174-2:2000.

5.5 Input/output communication

- Relay outputs
Alarm, ready and operating indication via signal relay.
- Digital input
 - Start/Stop (S/S)
 - Min. curve (MI)
 - Max. curve (MA).
- Analog input
0-10 V or 4-20 mA control signal.
To be used for external control of the pump or as sensor input for the control of the external setpoint.
The 24 V supply from pump to sensor is optional and is normally used when an external supply is not available.

5.5.1 Relay outputs

See fig. 15, pos. 1.

The pump incorporates two signal relays with a potential-free changeover contact for external fault indication.

The function of the signal relay can be set to "Alarm", "Ready" or "Operation" on the pump control panel or with Grundfos GO Remote.

The relays can be used for outputs up to 250 V and 2 A.

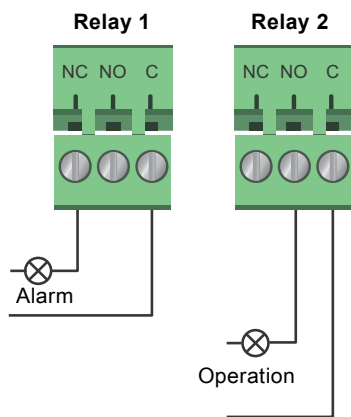

TMM05 33338 12/12

Fig. 17 Relay output

Contact symbol	Function
NC	Normally closed
NO	Normally open
C	Common

The functions of the signal relays appear from the table below:

Signal relay	Alarm signal
	Not activated: <ul style="list-style-type: none"> The power supply has been switched off. The pump has not registered a fault.
	Activated: <ul style="list-style-type: none"> The pump has registered a fault.
Signal relay	Ready signal
	Not activated: <ul style="list-style-type: none"> The pump has registered a fault and is unable to run.
	Activated: <ul style="list-style-type: none"> The pump has been set to stop, but is ready to run. The pump is running.
Signal relay	Operating signal
	Not activated: <ul style="list-style-type: none"> The pump is not running.
	Activated: <ul style="list-style-type: none"> The pump is running.

5.5.2 Digital inputs

See fig. 15, pos. 2.

The digital input can be used for external control of start/stop or forced max. or min. curve.

If no external on/off switch is connected, the jumper between terminals Start/Stop (S/S) and frame (⊥) should be maintained. This connection is the factory setting.

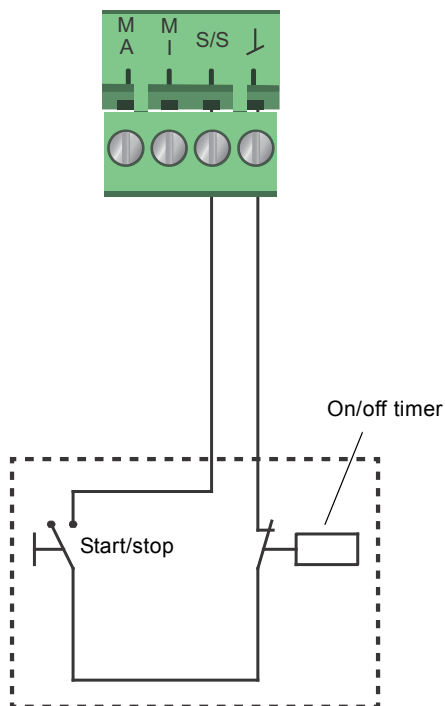
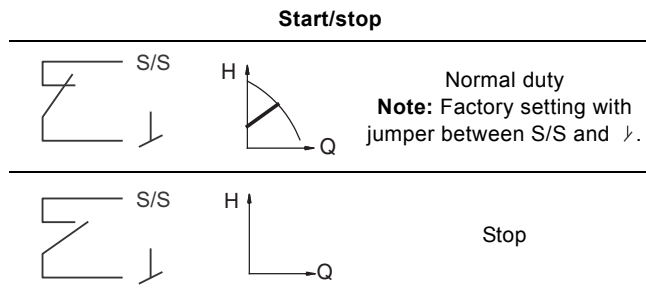

Fig. 18 Digital input

Contact symbol	Function
M A	Max. curve 100 % speed
M I	Min. curve 25 % speed
S/S	Start/Stop
⊥	Frame connection

External start/stop

The pump can be started or stopped via the digital input.



External forced max. or min. curve

The pump can be forced to operate on the max. or min. curve via the digital input.

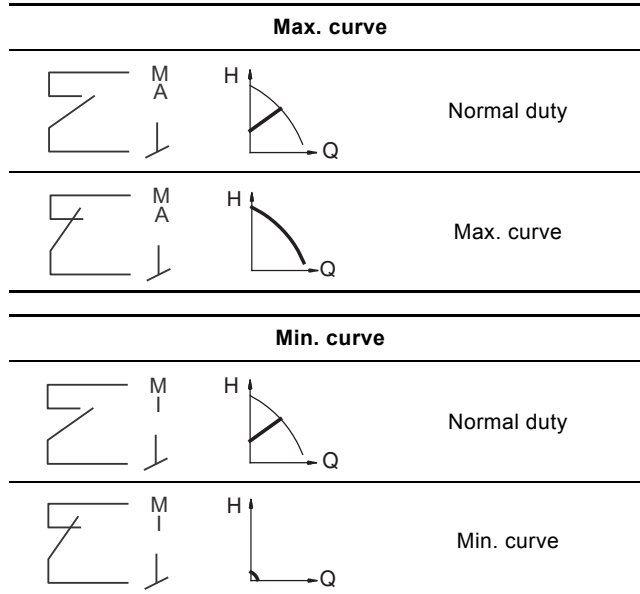

Select the function of the digital input on the pump control panel or with Grundfos GO Remote.

TM05 3339 1212

5.6 Analog input for external sensor

The analog input can be used for the connection of an external sensor for measuring temperature or pressure.

The analog input can also be used for an external signal for the control from a BMS system or similar control system.

The electrical signal for the input can be 0-10 VDC or 4-20 mA.

The selection of electrical signal (0-10 V or 4-20 mA) can be changed on the control panel or with Grundfos GO Remote.

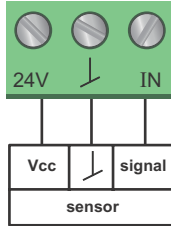

TM05 3221 1112

Fig. 19 Analog input for external sensor or control

In order to optimize the pump performance, external sensors can advantageously be used in the following cases:

Function/control mode	Sensor type
Heat energy meter	Temperature sensor
Constant temperature	Temperature sensor
Differential pressure	Pressure sensor

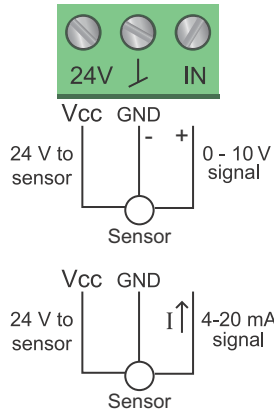

TM06 0882 1114

Fig. 20 Wiring, analog input

PIN	Description	Load
IN	Analog input	150 Ω (4-20 mA signal) 78 kΩ (0-10 V signal)
24 V	24 V supply to external sensor	Max. 22 mA
⌋	Ground for external sensor	

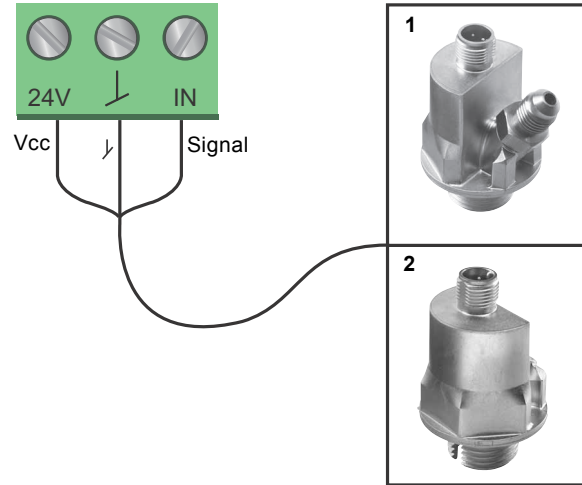

TM05 2947 1212

Fig. 21 Examples of external sensors

Pos.	Sensor type
1	Differential pressure transmitter, Grundfos type DPI V.2 1/2" connection and 4-20 mA signal.
2	Relative pressure transmitter, combined pressure and temperature sensor, Grundfos type RPI/T G 1/2" connection and 4-20 mA signal.

For further details, visit WebCAPS and reference Magna3 Data booklet 98439208.

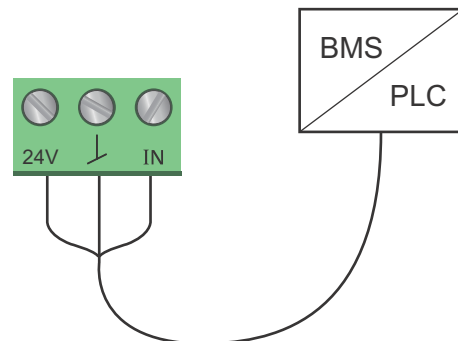

TM05 2888 0612

Fig. 22 Example of external signal for the control via BMS or PLC

5.7 Electrical connection for external sensor

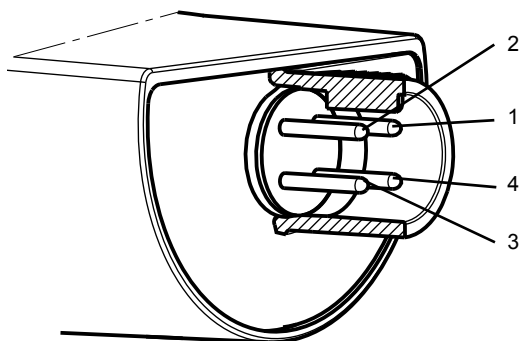

TM04 7156 1610

Fig. 23 Example electrical connections for external sensor

PIN	1	2	3	4
Wire color	Brown	Grey	Blue	Black
Output 4 to 20 mA	+	not used	-	not used
Output 2 x 0 to 10 V	+	Pressure signal	-*	Temperature signal

* Common ground for both pressure and temperature signal.

* Power supply (screened cable): SELV or PELV.

5.8 Priority of settings

The external forced-control signals will influence the settings available on the pump control panel or with Grundfos GO Remote. However, the pump can always be set to max. curve duty or to stop on the pump control panel or with Grundfos GO Remote.

If two or more functions are enabled at the same time, the pump will operate according to the setting with the highest priority.

The priority of the settings is as shown in the table below.

Example: If the pump has been forced to stop via an external signal, the pump control panel or Grundfos GO Remote can only set the pump to max. curve.





Priority	Possible settings		
	Pump control panel or Grundfos GO Remote	External signals	Bus signal
1	Stop		
2	Max. curve		
3		Stop	
4			Stop
5			Max. curve
6			Min. curve
7			Start
8		Max. curve	
9	Min. curve		
10		Min. curve	
11	Start		

As illustrated in the table, the pump does not react to external signals (max. curve and min. curve) when it is controlled via bus. For further details, please contact Grundfos.

6. First start-up

Do not start the pump until the system has been filled with liquid and vented. Furthermore, the required minimum inlet pressure must be available at the pump inlet. See section 19. [Technical data](#).

The system cannot be vented through the pump. The pump is self-venting.

Step	Action	Illustration
1	<p>Switch on the power supply to the pump. Note: When switched on, the pump will start in AUTO_{ADAPT} after approx. 5 seconds.</p>	 <p>TM05 2884 0612</p>
2	<p>Pump display at first start-up. After a few seconds, the pump display will change to the start-up guide.</p>	 <p>TM05 2885 0612</p>
3	<p>The start-up guide will guide you through the general settings of the pump, such as language, date and time. If the buttons on the pump control panel are not touched for 15 minutes, the display will go into sleep mode. When a button is touched, the "Home" display will appear.</p>	 <p>TM05 2886 0612</p>
4	<p>When the general settings have been made, select the desired control mode or let the pump run in AUTO_{ADAPT}. For additional settings, see section 7. Settings.</p>	 <p>TM05 2887 0612</p>

7. Settings



7.1 Overview of settings

All settings can be made on the pump control panel or with Grundfos GO Remote.

Menu	Submenu	Further information
Setpoint		See section 13.1 Setpoint .
Operating mode	<ul style="list-style-type: none"> • Normal • Stop • Min. • Max. 	See section 13.2 Operating mode .
Control mode	<ul style="list-style-type: none"> • AUTO_{ADAPT} • FLOW_{ADAPT} • Prop. press. • Const. press. • Const. temp. • Differential temperature • Constant curve 	See section 13.3 Control mode . See section 13.3.1 AUTOADAPT . See section 13.3.2 FLOWADAPT . See section 13.3.3 Proportional pressure . See section 13.3.4 Constant pressure . See section 13.3.5 Constant temperature . See section 13.3.6 Differential temperature . See section 13.3.7 Constant curve .
FLOW _{LIMIT}	<ul style="list-style-type: none"> • Set FLOWLIMIT 	See section 13.4 FLOWLIMIT .
Automatic Night Setback	<ul style="list-style-type: none"> • Not active • Active 	See section 13.5 Automatic Night Setback .
Relay outputs	<ul style="list-style-type: none"> • Relay output 1 • Relay output 2 	See section 13.6 Relay outputs .
Setpoint influence	<ul style="list-style-type: none"> • External setpoint function • Temperature influence 	See section 13.7 Setpoint influence . See section 13.7.1 External setpoint function . See section 13.7.2 Temperature influence .
Bus communication	<ul style="list-style-type: none"> • Pump number 	See section 13.8 Bus communication . See section 13.8.1 Pump number .
General settings	<ul style="list-style-type: none"> • Language • Set date and time • Units • Enable/disable settings • Delete history • Define Home display • Display brightness • Return to factory settings • Run start-up guide 	See section 13.9 General settings . See section 13.9.1 Language . See section 13.9.2 Set date and time . See section 13.9.3 Units . See section 13.9.4 Enable/disable settings . See section 13.9.5 Delete history . See section 13.9.6 Define Home display . See section 13.9.7 Display brightness . See section 13.9.8 Return to factory settings . See section 13.9.9 Run start-up guide .

8. Menu overview

Status	Settings	Assist
Operating status	Setpoint	Assisted pump setup
Operating mode, from	Operating mode	Setting of pump
Control mode	Control mode	Setting of date and time
Pump performance	FLOW _{LIMIT}	Date format, date and time
Max. curve and duty point	Enable FLOWLIMIT function	Date only
Resulting setpoint	Set FLOWLIMIT	Time only
Liquid temperature	Automatic Night Setback	Multi-pump setup
Speed	Relay outputs	Setup, analog input
Operating hours	Relay output 1	Description of control mode
Power and energy consumption	Relay output 2	AUTO _{ADAPT}
Power consumption	Not active	FLOW _{ADAPT}
Energy consumption	Ready	Prop. press.
Warning and alarm	Alarm	Const. press.
Actual warning or alarm	Operation	Const. temp.
Warning log	Setpoint influence	Differential temperature
Warning log 1 to 5	External setpoint function	Constant curve
Alarm log	Temperature influence	Assisted fault advice
Alarm log 1 to 5	Bus communication	Blocked pump
Heat energy meter	Pump number	Pump communication fault
Heat power	General settings	Internal fault
Heat energy	Language	Internal sensor fault
Flow rate	Set date and time	Dry running
Volume	Select date format	Forced pumping
Hours counter	Set date	Undervoltage
Temperature 1	Select time format	Overvoltage
Temperature 2	Set time	External sensor fault
Differential temp.	Units	
Operating log	SI or US units	
Operating hours	Customized units	
Trend data	Pressure	
Duty point over time	Differential pressure	
3D showing (Q, H, t)	Head	
3D showing (Q, T, t)	Level	
3D showing (Q, P, t)	Flow rate	
3D showing (T, P, t)	Volume	
Fitted modules	Temperature	
Date and time	Differential temp.	
Date	Power	
Time	Energy	
Pump identification	Enable/disable settings	
Multi-pump system	Delete history	
Operating status	Delete operating log	
Operating mode, from	Delete heat energy data	
Control mode	Delete energy consumption	
System performance	Define Home display	
Duty point	Select Home display type	
Resulting setpoint	List of data	
System identification	Graphical illustration	
Power and energy consumption	Define Home display contents	
Power consumption	List of data	
Energy consumption	Graphical illustration	
Other pump 1, multi-pump sys.	Display brightness	
	Brightness	
	Return to factory settings	
	Run start-up guide	

9. Control panel



Warning

At high liquid temperatures, the pump housing may be very hot. In that case, only touch the control panel.



TM05 7642 1313

Fig. 24 Control panel

Button	Function
	Goes to the "Home" menu.
	Returns to the previous action.
	Navigates between main menus, displays and digits. When the menu is changed, the display will always show the top display of the new menu.
	Navigates between submenus.
	Saves changed values, resets alarms and expands the value field.

10. Menu structure

The pump incorporates a start-up guide which is started at the first start-up. After the start-up guide, the four main menus will appear in the display. See section 6. [First start-up](#).

1. Home

This menu shows up to four user-defined parameters with shortcuts or a graphical illustration of a Q/H performance curve. See section 11. ["Home" menu](#).

2. Status

This menu shows the status of the pump and system as well as warnings and alarms. See section 12. ["Status" menu](#).

Note

No settings can be made in this menu.

3. Settings

This menu gives access to all setting parameters. A detailed setting of the pump can be made in this menu.

See section 13. ["Settings" menu](#).

4. Assist

This menu enables assisted pump setup, provides a short description of the control modes and offers fault advice.

See section 14. ["Assist" menu](#).

11. "Home" menu

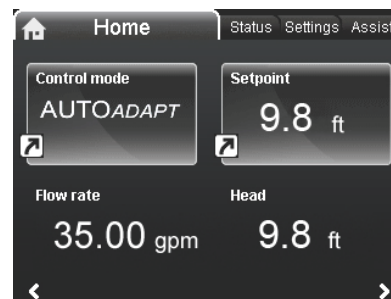

TM05 7929 1613

Navigation

Home

Press to go to the "Home" menu.

"Home" menu (factory setting)

- Shortcut to control mode settings
- Shortcut to setpoint settings
- Flow rate
- Head.

Navigate in the display with or and change between the two shortcuts with or .

The "Home" display can be defined by the user.

See section 13.9.6 [Define Home display](#).

12. "Status" menu

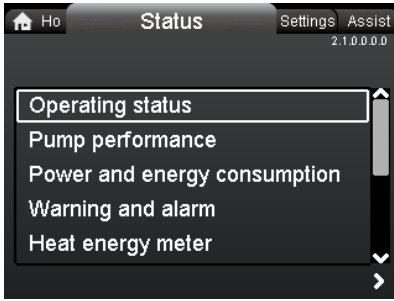

2.1.0.0.0 Status

Navigation

Home > Status

Press and go to the "Status" menu with .

"Status" menu

This menu offers the following status information:

- Operating status
- Pump performance
- Power and energy consumption
- Warning and alarm
- Heat energy meter
- Operating log
- Fitted modules
- Date and time
- Pump identification
- Multi-pump system.

Navigate between submenus with or .

13. "Settings" menu

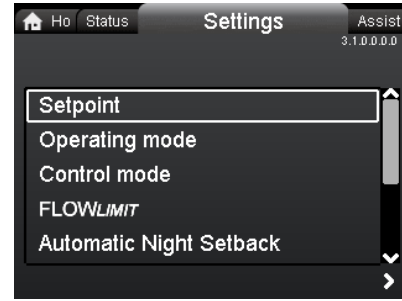

3.1.0.0.0 Settings

Navigation

Home > Settings

Press and go to the "Settings" menu with .

"Settings" menu

This menu offers the following setting options:

- Setpoint
- Operating mode
- Control mode
- FLOW_{LIMIT}
- Automatic Night Setback
- Relay outputs
- Setpoint influence
- Bus communication
- General settings.

Navigate between submenus with or .

13.1 Setpoint

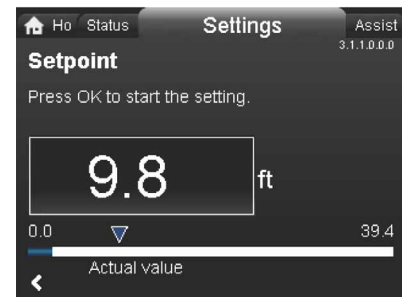

TM05 7925 1613

Navigation

Home > Settings > Setpoint

Setpoint

Set the setpoint so that it matches the system.

Setting:

1. Press [OK] to start the setting.
2. Select digit with and and adjust with or .
3. Press [OK] to save.

A too high setting may result in noise in the system whereas a too low setting may result in insufficient heating or cooling in the system.

Control mode	Measuring unit
Proportional pressure	m, ft
Constant pressure	m, ft
Constant temperature	°C, °F, K
Constant curve	%

13.2 Operating mode

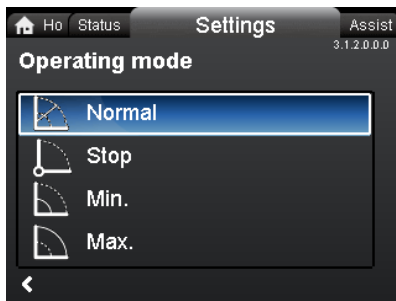

3.1.2.0.0.0 Operating mode

Navigation

Home > Settings > Operating mode

Operating mode

- Normal (control mode)
- Stop
- Min. (min. curve)
- Max. (max. curve).

Setting:

1. Select operating mode with \downarrow or \uparrow .
2. Press [OK] to save.

The pump can be set to operate according to the max. or min. curve, like an uncontrolled pump. See fig. 25.

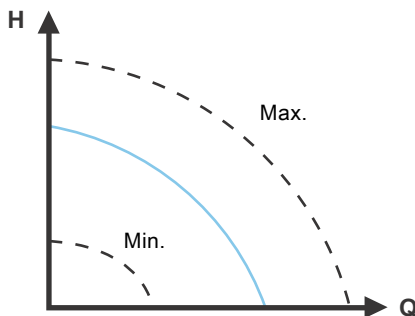

TM05 2446 5111

Fig. 25 Max. and min. curves

- **Normal:** The pump runs according to the selected control mode.
- **Stop:** The pump stops.
- **Min.:** The min. curve mode can be used in periods in which a minimum flow is required. This operating mode is for instance suitable for manual night setback if Automatic Night Setback is not desired.
- **Max.:** The max. curve mode can be used in periods in which a maximum flow is required. This operating mode is for instance suitable for hot-water priority.

13.3 Control mode

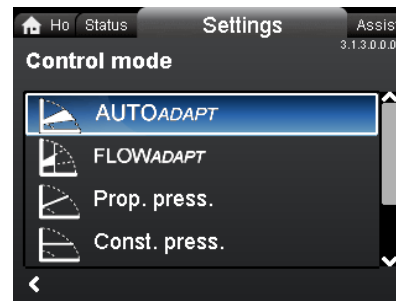

3.1.3.0.0.0 Control mode

Navigation

Home > Settings > Control mode

Control mode

- $AUTO_{ADAPT}$
- $FLOW_{ADAPT}$
- Prop. press. (proportional pressure)
- Const. press. (constant pressure)
- Const. temp.(constant temperature)
- Constant curve.

Note

The operating mode must be set to "Normal" before a control mode can be enabled.

Setting:

1. Select control mode with \downarrow or \uparrow .
2. Press [OK] to enable.

The setpoint for all control modes, except $AUTO_{ADAPT}$ and $FLOW_{ADAPT}$, can be changed in the "Setpoint" submenu under "Settings" when the desired control mode has been selected.

All control modes, except "Constant curve", can be combined with Automatic Night Setback. See section [13.5 Automatic Night Setback](#).

The $FLOW_{LIMIT}$ function can also be combined with the last five control modes mentioned above. See section [13.4 FLOWLIMIT](#).

13.3.1 AUTO_{ADAPT}

The AUTO_{ADAPT} control mode continuously adapts the pump performance according to the actual system characteristic.

Note Manual setting of the setpoint is not possible.

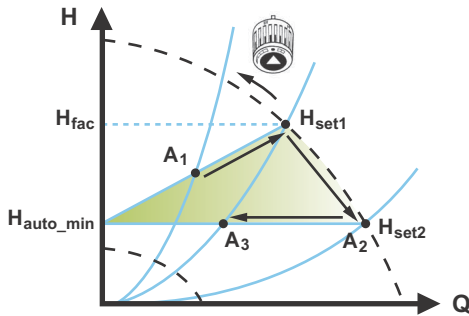

Fig. 26 AUTO_{ADAPT}

When the AUTO_{ADAPT} control mode has been enabled, the pump will start with the factory setting, $H_{fac} = H_{set1}$, corresponding to approx. 55 % of its maximum head, and then adjust its performance to A_1 . See fig. 26.

When the pump registers a lower head on the max. curve, A_2 , the AUTO_{ADAPT} function will automatically select a correspondingly lower control curve, H_{set2} . If the valves in the system close, the pump will adjust its performance to A_3 .

- A_1 : Original duty point.
- A_2 : Lower registered head on the max. curve.
- A_3 : New duty point after AUTO_{ADAPT} control.
- H_{set1} : Original setpoint setting.
- H_{set2} : New setpoint after AUTO_{ADAPT} control.
- H_{fac} : MAGNA3 xx-60: 11.4 ft (3.5 m)
MAGNA3 xx-80: 14.7 ft (4.5 m)
MAGNA3 xx-100: 18 ft (5.5 m)
MAGNA3 xx-120: 21.3 ft (6.5 m)
MAGNA3 xx-150: 26.2 ft (8.0 m)
MAGNA3 xx-180: 31.1 ft (9.5 m).

H_{auto_min} : A fixed value of 4.9 ft (1.5 m).

The AUTO_{ADAPT} control mode is a form of proportional-pressure control where the control curves have a fixed origin, H_{auto_min} .

The AUTO_{ADAPT} control mode has been developed specifically for heating systems and is not recommended for air-conditioning and cooling systems.

To reset AUTO_{ADAPT}, see section [13.9.8 Return to factory settings](#).

13.3.2 FLOW_{ADAPT}

When FLOW_{ADAPT} is selected, the pump will run AUTO_{ADAPT} and ensure that the flow never exceeds the entered FLOW_{LIMIT} value. The setting range for the FLOW_{LIMIT} is 25 to 90 % of the Q_{max} of the pump.

The factory setting of the FLOW_{LIMIT} is the flow where the AUTO_{ADAPT} factory setting meets the max. curve. See fig. 27.

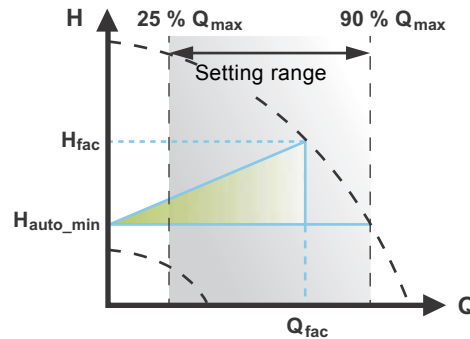

Fig. 27 FLOW_{ADAPT}

13.3.3 Proportional pressure

The pump head is reduced at decreasing water demand and increased at rising water demand. See fig. 28.

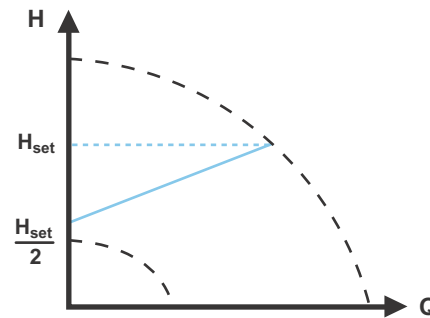

Fig. 28 Proportional pressure

TM05 2452 1312

TM05 3334 1212

TM05 2448 1212

13.3.4 Constant pressure

The pump maintains a constant pressure, irrespective of water demand. See fig. 29.

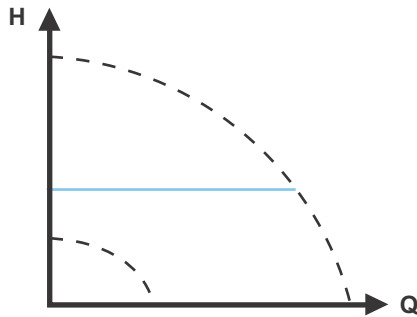

Fig. 29 Constant pressure

13.3.5 Constant temperature

This control mode ensures a constant temperature. Constant temperature is a comfort control mode that can be used in domestic hot-water systems to control the flow to maintain a fixed temperature in the system. See fig. 30. When this control mode is used, no balancing valves must be installed in the system.

If the pump is installed in the return pipe of the system, the internal temperature sensor can be used. In this case, the pump must be installed as close as possible to the consumer (radiator, heat exchanger, etc.).

If the pump is installed in the flow pipe, an external temperature sensor must be installed in the return pipe of the system. The sensor must be installed as close as possible to the consumer (radiator, heat exchanger, etc.).

The constant-temperature control mode also reduces the risk of bacterial growth (for example Legionella) in the system.

It is possible to set the sensor range:

- min. +14 °F (-10 °C)
- max. +266 °F (+130 °C).

Note

To ensure that the pump is able to control, we recommend to set the sensor range between +3 °F and +257 °F (-5 and +125 °C).

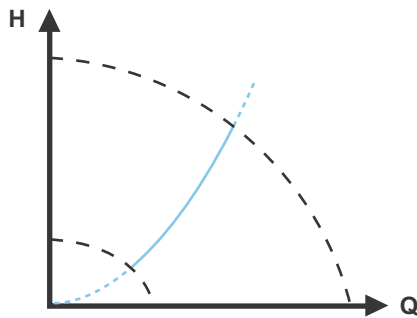

Fig. 30 Constant temperature

13.3.6 Differential temperature

This control mode ensures a constant differential temperature drop across a heating system.

The pump should be installed in the flow pipe so the built-in sensor measures the liquid temperature going out to the load. An external temperature sensor must be installed in the system to measure the liquid temperature returning from the heating load. In this mode, the pump will maintain a constant temperature. See figs 31 and 32, differential between the pump and the external sensor.

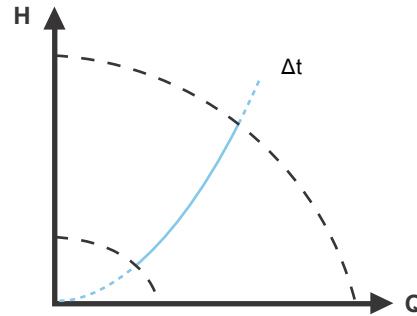

Fig. 31 Differential temperature

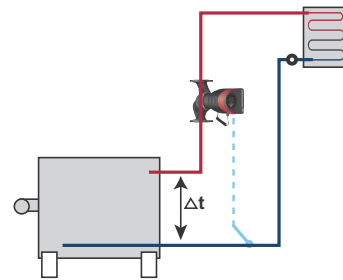

Fig. 32 Differential temperature

Note

Changing K_p and T_i values are only possible with Grundfos GO.

Note

Changing the K_p and T_i values will affect all control modes. If the control mode is to be changed back to another mode you must set the K_p and T_i values back to default values. For all other modes the default values are $K_p = 0.5$, $T_i = 0.5$.

TM05 2449 0312

TM05 2451 5111

TM05 8236 2113

TM05 2451 5111

See table, fig. 33.

The table shows the suggested controller settings:

System/application	K_p		T_i
	Heating system ¹⁾	Cooling system ²⁾	
	0.5	-0.5	$10 + 5L_2$
	-0.5		$10 + 5L_2$
	0.5	-0.5	$30 + 5L_2$

Fig. 33 Suggested controller settings

- 1) Heating systems are systems in which an increase in pump performance will result in a **rise** in temperature at the sensor.
- 2) Cooling systems are systems in which an increase in pump performance will result in a **drop** in temperature at the sensor.

L_2 = Distance in [m] between heat exchanger and sensor.

Proceed as follows:

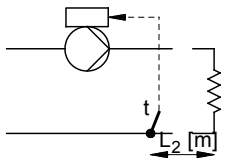
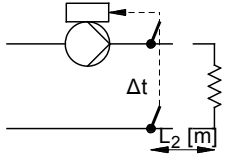
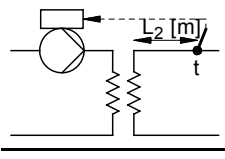
1. Increase the gain (K_p) until the motor becomes unstable. Instability can be seen by observing if the measured value starts to fluctuate. Furthermore, instability is audible as the motor starts hunting up and down. Some systems, such as temperature controls, are slow-reacting, meaning that it may be several minutes before the motor becomes unstable.
2. Set the gain (K_p) to half the value of the value which made the motor unstable. This is the correct setting of the gain.
3. Reduce the integral time (T_i) until the motor becomes unstable.
4. Set the integral time (T_i) to twice the value which made the motor unstable. This is the correct setting of the integral time.

General rules of thumb:

- If the controller is too slow-reacting, increase K_p .
- If the controller is hunting or unstable, dampen the system by reducing K_p or increasing T_i .

13.3.7 Constant curve

The pump can be set to operate according to a constant curve, like an uncontrolled pump. See fig. 34.

The desired speed can be set in % of maximum speed in the range from 25 to 100 %.

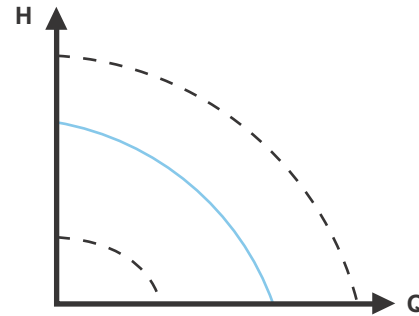

Fig. 34 Constant curve

Depending on the system characteristic and the duty point, the 100 % setting may be slightly smaller than the pump's actual max. curve even though the display shows 100 %. This is due to power and pressure limitations built into the pump. The deviation varies according to pump type and pressure loss in the pipes.

Note

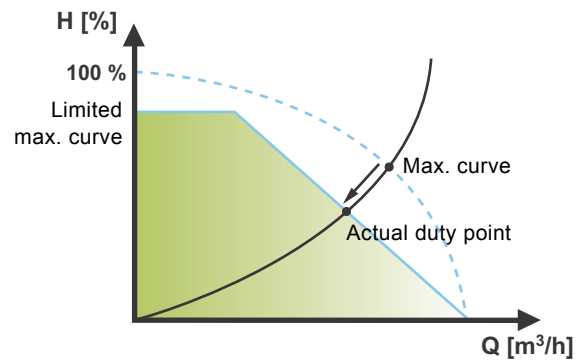
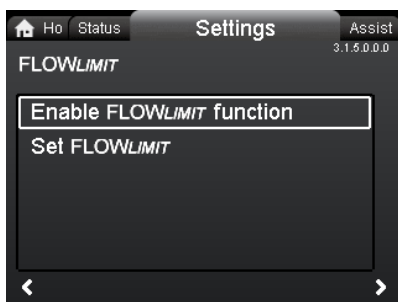

Fig. 35 Power and pressure limitations influencing the max. curve

TM05 2446 0312

TM05 3041 1212

13.4 FLOW_{LIMIT}

3.1.5.0.0.0 FLOW_{LIMIT}

Navigation

Home > Settings > FLOW_{LIMIT}

FLOW_{LIMIT}

- Enable FLOWLIMIT function
- Set FLOWLIMIT.

Setting:

1. To enable the function, select "Active" with \blacktriangledown or \blacktriangle and press [OK].
2. To set the FLOW_{LIMIT}, press [OK] to start the setting.
3. Select digit with \blacktriangleleft and \blacktriangleright and adjust with \blacktriangledown or \blacktriangle .
4. Press [OK] to save.

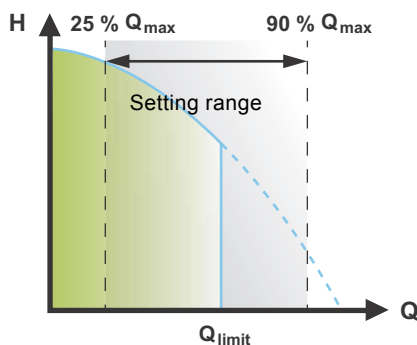

TM05 2445 1212

Fig. 36 FLOW_{LIMIT}

The FLOW_{LIMIT} function can be combined with the following control modes:

- Prop. press.
- Const. press.
- Const. temp.
- Constant curve.

A flow-limiting function ensures that the flow never exceeds the entered FLOW_{LIMIT} value.

The setting range for FLOW_{LIMIT} is 25 to 90 % of the Q_{max} of the pump.

The factory setting of the FLOW_{LIMIT} is the flow where the AUTO_{ADAPT} factory setting meets the max. curve. See fig. 27.

13.5 Automatic Night Setback

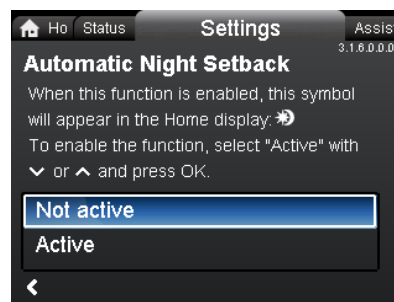

3.1.6.0.0.0 Automatic Night Setback

Navigation

Home > Settings > Automatic Night Setback

Automatic Night Setback

To enable the function, select "Active" with \blacktriangledown or \blacktriangle and press [OK].

Once Automatic Night Setback has been enabled, the pump automatically changes between normal duty and night setback (duty at low performance).

Changeover between normal duty and night setback depends on the flow-pipe temperature.

The pump automatically changes over to night setback when the built-in sensor registers a flow-pipe temperature drop of more than +18 to +27 °F (-8 to -3 °C) within approx. two hours.

The temperature drop must be at least 0.18 °F/min (0.1 °C/min).

Changeover to normal duty takes place without a time lag when the temperature has increased by approx. +18 °F (-8 °C).

Note

Automatic Night Setback cannot be enabled when the pump is in constant-curve mode.

13.6 Relay outputs



3.1.12.0.0.0 Relay outputs

Navigation

Home > Settings > Relay outputs

Relay outputs

- Relay output 1
- Relay output 2.

The relay outputs can be set to the following:

- Not active
- Ready
- Alarm
- Operation.

The pump incorporates two signal relays, terminals 1, 2 and 3, for a potential-free alarm signal, ready signal and operating signal. For further information, see section [5.5.1 Relay outputs](#).

Set the function of the signal relays, alarm signal (factory setting), ready signal and operating signal, on the pump control panel.

The output, terminals 1, 2 and 3, is electrically separated from the rest of the controller.

The signal relay is operated as follows:

- Not active
The signal relay is deactivated.
- Ready
The signal relay is active when the pump is running or has been set to stop, but is ready to run.
- Alarm
The signal relay is activated together with the red indicator light on the pump.
- Operation
The signal relay is activated together with the green indicator light on the pump.

13.7 Setpoint influence

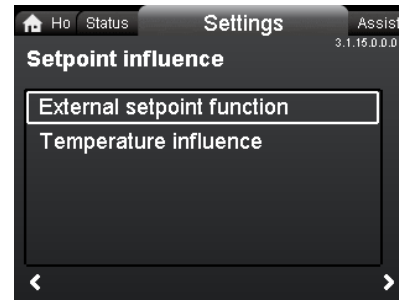

3.1.15.0.0.0 Setpoint influence

Navigation

Home > Settings > Setpoint influence

Setpoint influence

- External setpoint function
- Temperature influence.

13.7.1 External setpoint function

Range		
4-20 mA	[0-100 %]	
0-10 V	[0-100 %]	
Control		
0-20 %	(e.g. 0-2 V)	Setpoint = Min.
20-100 %	(e.g. 2-10 V)	Setpoint = Min. ↔ setpoint

The external setpoint function is an external 0-10 V or 4-20 mA signal that will control the pump speed in a range from 0 to 100 % in a linear function. See fig. [37](#).

Before the "External setpoint function" can be enabled, the analog input must be set to "External setpoint influence" via the "Assist" menu.

See section [5.6 Analog input for external sensor](#).

Note

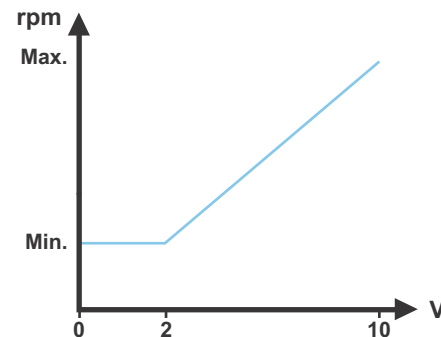

Fig. 37 External setpoint function, 0-10 V

TM05 3219 1212

13.7.2 Temperature influence

When this function is enabled in proportional- or constant-pressure control mode, the setpoint for head will be reduced according to the liquid temperature.

Temperature influence can be set to function at liquid temperatures below +176 °F or +122 °F (80 °C or 50 °C). These temperature limits are called T_{max} . The setpoint is reduced in relation to the head set (= 100 %) according to the characteristics below.

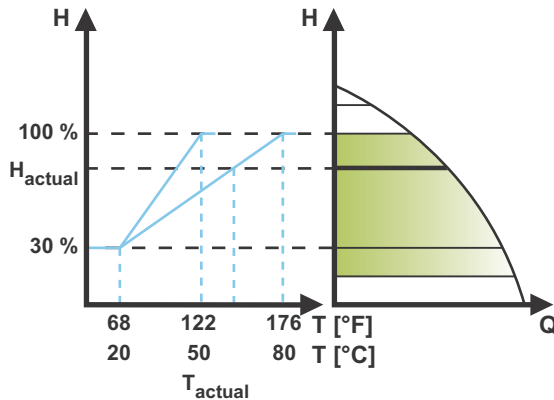

Fig. 38 Temperature influence

In the above example, $T_{max} = +176$ °F (+80 °C) has been selected.

The actual liquid temperature T_{actual} causes the setpoint for head to be reduced from 100 % to H_{actual} .

The temperature influence function requires the following:

- Proportional-pressure, constant-pressure or constant-curve control mode.
- Pump installed in flow pipe.
- System with flow-pipe temperature control.

Temperature influence is suitable for the following systems:

- Systems with variable flows (for example two-pipe heating systems) in which the enabling of the temperature influence function will ensure a further reduction of the pump performance in periods with small heating demands and consequently a reduced flow-pipe temperature.
- Systems with almost constant flows (for example one-pipe heating systems and underfloor heating systems), in which variable heating demands cannot be registered as changes in the head as is the case with two-pipe heating systems. In such systems, the pump performance can only be adjusted by enabling the temperature influence function.

Selection of T_{max} .

In systems with a dimensioned flow-pipe temperature of:

- up to and including +131 °F (+55 °C), select $T_{max} = +122$ °F (+50 °C)
- above +131 °F (+55 °C), select $T_{max} = +176$ °F (80 °C).

Note

The temperature influence function cannot be used in air-conditioning and cooling systems.

13.8 Bus communication

13.8.1 Pump number

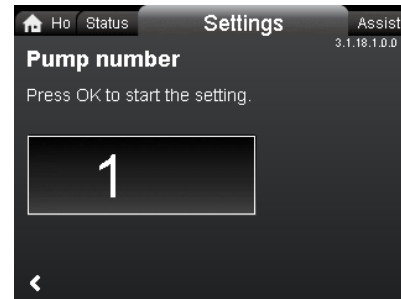

Navigation

Home > Settings > Bus communication > Pump number

Pump number

A unique number can be allocated to the pump. This makes it possible to distinguish between pumps in connection with bus communication.

13.9 General settings

13.9.1 Language

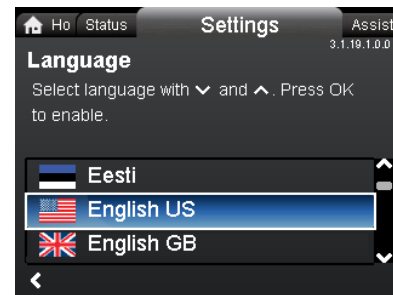

Navigation

Home > Settings > General settings > Language

Language

The display can be shown in any of the following languages: GB, BG, CZ, DK, DE, EE, GR, ES, FR, HR, IT, LV, LT, HU, NL, UA, PL, PT, RU, RO, SK, SI, RS, FI, SE, TR, CN, JP or KO.

Measuring units are automatically changed according to selected language.

Setting:

1. Select language with \downarrow and \uparrow .
2. Press [OK] to enable.

13.9.2 Set date and time

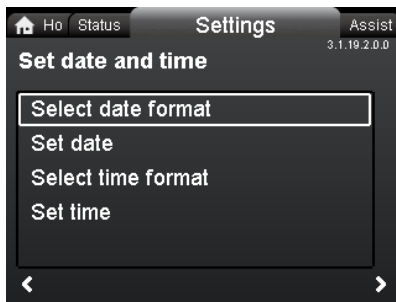

3.1.19.2.0.0 Set date and time

Navigation

Home > Settings > General settings > Set date and time

Set date and time

- Select date format
- Set date
- Select time format
- Set time.

Set the real-time clock in this menu.

Select date format

- YYYY-MM-DD
- DD-MM-YYYY
- MM-DD-YYYY.

Setting:

1. Select "Set date".
2. Press [OK] to start the setting.
3. Select digit with < and > and adjust with v or ^.
4. Press [OK] to save.

Select time format

- HH:MM 24-hour clock
- HH:MM am/pm 12-hour clock.

Setting:

1. Select "Set time".
2. Press [OK] to start the setting.
3. Select digit with < and > and adjust with v or ^.
4. Press [OK] to save.

13.9.3 Units

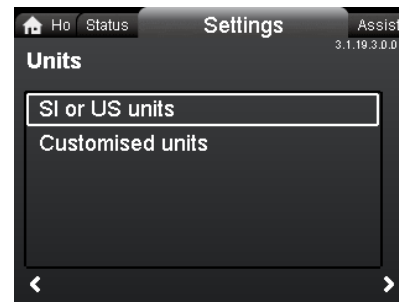

3.1.19.3.0.0 Units

Navigation

Home > Settings > General settings > Units

Units

- SI or US units
- Customized units.

Select whether the display should show SI or US units or select the desired units for the parameters below.

- Pressure
- Differential pressure
- Head
- Level
- Flow rate
- Volume
- Temperature
- Differential temp.
- Power
- Energy.

Setting:

1. Select parameter and press [OK].
2. Select unit with v or ^.
3. Press [OK] to enable.

If "SI or US units" is selected, the customized units will be reset.

13.9.4 Enable/disable settings

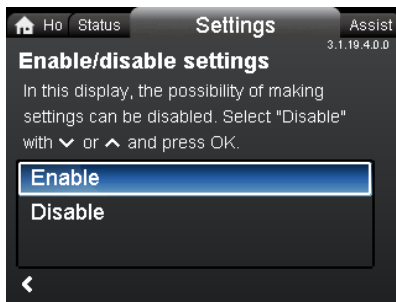

3.1.19.4.0.0 Enable/disable settings

Navigation

Home > Settings > General settings > Enable/disable settings

Enable/disable settings

In this display, the possibility of making settings can be disabled for protective reasons.

Select "Disable" with ∇ or \blacktriangle and press [OK].

The pump will now be locked for settings. Only the "Home" display will be available.

To unlock the pump and allow settings, press ∇ and \blacktriangle simultaneously for at least 5 seconds.

13.9.5 Delete history

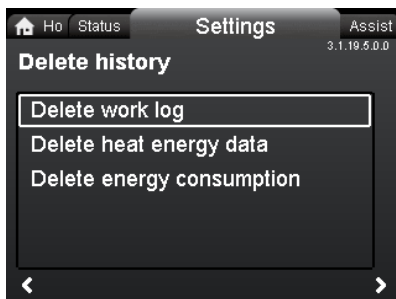

3.1.19.5.0.0 Delete history

Navigation

Home > Settings > General settings > Delete history

Delete history

- Delete operating log
- Delete heat energy data
- Delete energy consumption.

It is possible to delete data from the pump, for example if the pump is moved to another system or if new data are required due to changes to the system.

Setting:

1. Select the relevant submenu and press [OK].
2. Select "Yes" with ∇ or \blacktriangle and press [OK] or press \odot to cancel.

13.9.6 Define Home display

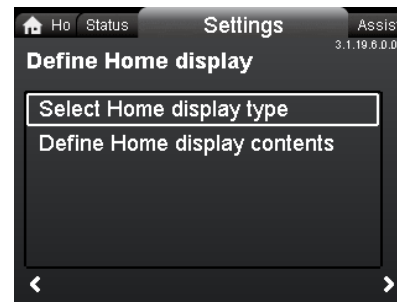

3.1.19.6.0.0 Define Home display

Navigation

Home > Settings > General settings > Define Home display
Define Home display

- Select Home display type
- Define Home display contents.

The "Home" display can be set to show up to four user-defined parameters or a graphical illustration of a performance curve.

Select Home display type

1. Select "List of data" or "Graphical illustration" with ∇ or \blacktriangle .
2. Press [OK] to save.

To specify the contents, go to "Define Home display contents".

Define Home display contents

1. To set "List of data", press [OK] to start the setting.
A list of parameters will appear in the display.
2. Select or deselect with [OK].
Up to four parameters can be selected.

The selected parameters will be shown as illustrated below.

The arrow icon indicates that the parameter links to the "Settings" menu and works as a shortcut for quick settings.

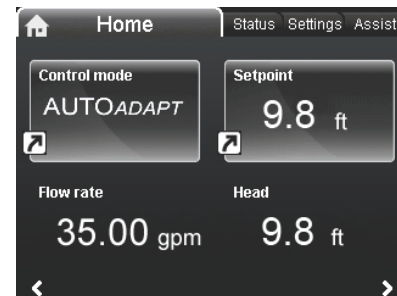

TM05 7929 1613

1. To set "Graphical illustration", press [OK] to start the setting.
2. Select the desired curve and press [OK] to save.

13.9.7 Display brightness

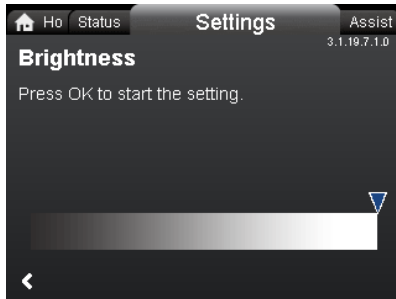

3.1.19.7.1.0 Brightness

Navigation

Home > Settings > General settings > Display brightness

Brightness

1. Press [OK] to start the setting.
2. Set brightness with ◀ and ▶.
3. Press [OK] to save.

13.9.8 Return to factory settings

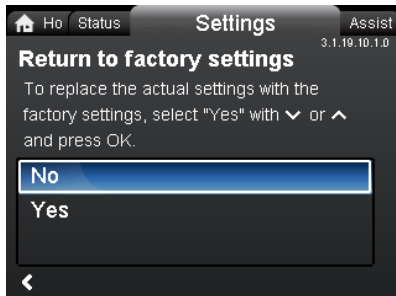

3.1.19.10.1.0 Return to factory settings

Navigation

Home > Settings > General settings > Return to factory settings

Return to factory settings

It is possible to recall the factory settings and overwrite the current settings. All user settings in the "Settings" and "Assist" menus will be set back to the factory settings. This also includes language, units, possible setup of analog input, multi-pump function, etc.

To overwrite the current settings with the factory settings, select "Yes" with ▼ or ▲ and press [OK].

13.9.9 Run start-up guide

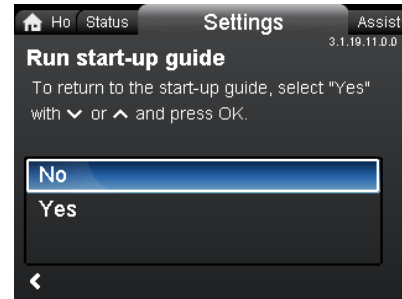

3.1.19.11.0.0 Run start-up guide

Navigation

Home > Settings > General settings > Run start-up guide

Run start-up guide

It is possible to run the start-up guide again. The start-up guide will guide the user through the general settings of the pump, such as language, date and time.

To run the start-up guide, select "Yes" with ▼ or ▲ and press [OK].

14. "Assist" menu

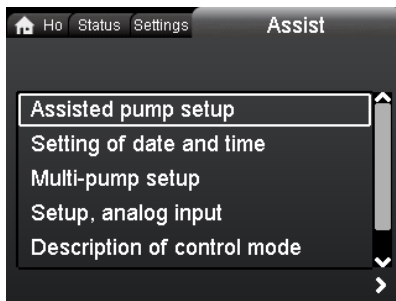

Assist

Navigation

Home > Assist

Press and go to the "Assist" menu with .

"Assist" menu

This menu offers the following:

- Assisted pump setup
- Setting of date and time
- Multi-pump setup
- Setup, analog input
- Description of control mode
- Assisted fault advice.

The "Assist" menu guides the user through the setting of the pump. In each submenu, the user is presented with a guide that helps throughout the setting.

14.1 Assisted pump setup

This submenu is a step-by-step guide to complete pump setup, starting with a presentation of the control modes and ending with the setpoint setting.

14.2 Setting of date and time

See section [13.9.2 Set date and time](#).

14.3 Multi-pump setup

This submenu assists the user in setting up a multi-pump system. See section [14.8 Multi-pump function](#).

14.4 Setup, analog input

This submenu assists the user in setting up the analog input.

14.5 Description of control mode

This submenu gives a short description of each control mode.

14.6 Assisted fault advice

This submenu provides information about faults and corrective actions.

14.7 Wireless GENlair

The pump is designed for multi-pump connection via the wireless GENlair connection or wired via a bus system (Building Management System).

The built-in wireless GENlair module enables communication between pumps and with Grundfos Go Remote without the use of add-on modules:

- Multi-pump function.
See section [14.8 Multi-pump function](#).
- Grundfos GO Remote.
See section [18.1 Grundfos GO Remote](#).

14.8 Multi-pump function

The multi-pump function enables the control of single-head pumps connected in parallel and twin-head pumps without the use of external controllers. The pumps in a multi-pump system communicate with each other via the wireless GENlair connection.

A multi-pump system is set up via a selected pump, i.e. the master pump (first selected pump). All Grundfos pumps with a wireless GENlair connection can be connected to the multi-pump system.

The multi-pump functions are described in the following sections.

14.8.1 Alternating operation

Only one pump is operating at a time. The change from one pump to the other depends on time or energy. If a pump fails, the other pump will take over automatically.

Pump system:

- Twin-head pump.
- Two single-head pumps connected in parallel. The pumps must be of same type and size. Each pump requires a non-return valve in series with the pump.

14.8.2 Back-up operation

One pump is operating continuously. The back-up pump is operated at intervals to prevent seizing up. If the duty pump stops due to a fault, the back-up pump will start automatically.

Pump system:

- Twin-head pump.
- Two single-head pumps connected in parallel. The pumps must be of same type and size. Each pump requires a non-return valve in series with the pump.

14.8.3 Cascade operation

Cascade operation ensures that the pump performance is automatically adapted to the consumption by switching pumps on or off. The system thus runs as energy-efficiently as possible with a constant pressure and a limited number of pumps.

All pumps in operation will run at equal speed. Pump changeover is automatic and depends on energy, operating hours and fault.

Pump system:

- Twin-head pump.
- Two single-head pumps connected in parallel. The pumps must be of same type and size. Each pump requires a non-return valve in series with the pump.
- The control mode must be set to "Const. press." or "Constant curve".

15. Selection of control mode

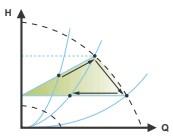
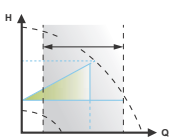
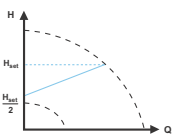
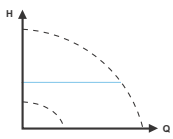
System application	Select this control mode
<p>Recommended for most heating systems, especially in systems with relatively large pressure losses in the distribution pipes. See description under proportional pressure.</p> <p>In replacement situations where the proportional-pressure duty point is unknown.</p> <p>The duty point has to be within the $AUTO_{ADAPT}$ operating range. During operation, the pump automatically makes the necessary adjustment to the actual system characteristic.</p> <p>This setting ensures minimum energy consumption and noise level from valves, which reduces operating costs and increases comfort.</p>	<p>$AUTO_{ADAPT}$</p> 
<p>The $FLOW_{ADAPT}$ control mode is a combination of $AUTO_{ADAPT}$ and $FLOW_{LIMIT}$.</p> <p>This control mode is suitable for systems where a maximum flow limit, $FLOW_{LIMIT}$, is desired. The pump continuously monitors and adjusts the flow, thus ensuring that the selected $FLOW_{LIMIT}$ is not exceeded.</p> <p>Main pumps in boiler applications where a steady flow through the boiler is required. No extra energy is used for pumping too much liquid into the system.</p> <p>In systems with mixing loops, the control mode can be used to control the flow in each loop.</p> <p>Benefits:</p> <ul style="list-style-type: none"> • Enough water for all loops at peak load conditions if each loop has been set to the right maximum flow. • The dimensioned flow for each zone (required heat energy) is determined by the flow from the pump. This value can be set precisely in the $FLOW_{ADAPT}$ control mode without the use of pump throttling valves. • When the flow is set lower than the balancing valve setting, the pump will ramp down instead of losing energy by pumping against a balancing valve. • Cooling surfaces in air-conditioning systems can operate at high pressure and low flow. 	<p>$FLOW_{ADAPT}$</p> 
<p>In systems with relatively large pressure losses in the distribution pipes and in air-conditioning and cooling systems.</p> <ul style="list-style-type: none"> • Two-pipe heating systems with thermostatic valves and <ul style="list-style-type: none"> – a dimensioned pump head higher than 13 ft (4 meters) – very long distribution pipes – strongly throttled pipe balancing valves – differential-pressure regulators – large pressure losses in those parts of the system through which the total quantity of water flows (for example boiler, heat exchanger and distribution pipe up to the first branching). • Primary circuit pumps in systems with large pressure losses in the primary circuit. • Air-conditioning systems with <ul style="list-style-type: none"> – heat exchangers (fan coils) – cooling ceilings – cooling surfaces. 	<p>Proportional pressure</p> 
<p>In systems with relatively small pressure losses in the distribution pipes.</p> <ul style="list-style-type: none"> • Two-pipe heating systems with thermostatic valves and <ul style="list-style-type: none"> – a dimensioned pump head lower than 6.5 ft (2 meters) – dimensioned for natural circulation – small pressure losses in those parts of the system through which the total quantity of water flows (for example boiler, heat exchanger and distribution pipe up to the first branching) or – modified to a high differential temperature between flow pipe and return pipe (for example district heating). • Underfloor heating systems with thermostatic valves. • One-pipe heating systems with thermostatic valves or pipe balancing valves. • Primary circuit pumps in systems with small pressure losses in the primary circuit. 	<p>Constant pressure</p> 

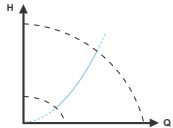
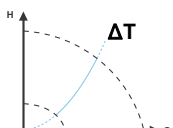
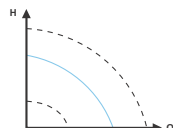
System application	Select this control mode
<p>In heating systems with a fixed system characteristic, for example domestic hot-water systems, the control of the pump according to a constant return-pipe temperature may be relevant.</p> <p>$FLOW_{LIMIT}$ can be used with advantage to control the maximum circulation flow.</p>	<p>Constant temperature</p> 
<p>In a heating system where a constant temperature drop across the system is desired, constant differential temperature can be used.</p> <p>This mode requires an external temperature sensor for the second temperature measurement.</p>	<p>Differential temperature</p> 
<p>If an external controller is installed, the pump is able to change from one constant curve to another, depending on the value of the external signal.</p> <p>The pump can also be set to operate according to the max. or min. curve, like an uncontrolled pump:</p> <ul style="list-style-type: none"> • The max. curve mode can be used in periods in which a maximum flow is required. This operating mode is for instance suitable for hot-water priority. • The min. curve mode can be used in periods in which a minimum flow is required. This operating mode is for instance suitable for manual night setback if Automatic Night Setback is not desired. 	<p>Constant curve</p> 
<p>In systems with pumps operating in parallel.</p> <p>The multi-pump function enables the control of single-head pumps connected in parallel (two pumps) and twin-head pumps without the use of external controllers. The pumps in a multi-pump system communicate with each other via the wireless GENIair connection.</p>	<p>"Assist" menu "Multi-pump setup"</p>

16. Fault finding



Warning

Before dismantling the pump, drain the system or close the isolating valve on either side of the pump. The pumped liquid may be scalding hot and under high pressure.

16.1 Grundfos Eye operating indications

Grundfos Eye	Indication	Cause
	No lights on.	Power off. Pump not running.
	Two opposite green indicator lights running in the direction of rotation of the pump.	Power on. Pump running.
	Two opposite green indicator lights permanently on.	Power on. Pump not running.
	One yellow indicator light running in the direction of rotation of the pump.	Warning. Pump running.
	One yellow indicator light permanently on.	Warning. Pump stopped.
	Two opposite red indicator lights flashing simultaneously.	Alarm. Pump stopped.
	One green indicator light in the middle permanently on (in addition to another indication).	Remote-controlled. The pump is currently being accessed by Grundfos GO Remote.

16.2 Signalling communication with remote control

The center indicator light in the Grundfos Eye will indicate communication with Grundfos GO Remote.

The table below describes the desired function of the center indicator light.

Case	Description	Signalling by the center indicator light
Wink	The pump in question is highlighted in the Grundfos GO Remote display. To inform the user of the location of the highlighted pump, the center indicator light will flash four or five times once to signal "I am here".	Four or five quick flashes once to signal "I am here".
Push me	The pump in question is selected/opened in the Grundfos GO Remote menu. The pump will signal "Push me" to ask the user to select the pump/allow the pump to exchange data with Grundfos GO Remote. The indicator light will flash continuously until a pop-up window asks the user to press [OK] to allow communication with Grundfos GO Remote.	Flashing continuously with 50 % duty cycle.
I am connected	The indicator light is signalling that the pump is connected to Grundfos GO Remote. The indicator light is permanently on as long as the pump is selected in Grundfos GO Remote.	Indicator light permanently on.

16.3 Fault finding

A fault indication can be reset in one of the following ways:

- When the fault cause has been eliminated, the pump will revert to normal duty.
- If the fault disappears by itself, the fault indication will automatically be reset.
- The fault cause will be stored in the pump alarm log.

Warning and alarm codes	Fault	Automatic reset and restart?	Corrective actions
Pump communication fault (10) Alarm	Communication fault between different parts of the electronics.	Yes	Replace the pump, or call GRUNDFOS SERVICE for assistance. Check if the pump is running in turbine operation. See code (29) Forced pumping.
Forced pumping (29) Alarm	Other pumps or sources force flow through the pump even if the pump is stopped and switched off.	Yes	Switch off the pump on the main switch. If the light in the Grundfos Eye is on, the pump is running in forced-pumping mode. Check the system for defective non-return valves and replace, if necessary. Check the system for correct position of non-return valves, etc.
Undervoltage (40, 75) Alarm	Supply voltage to the pump too low.	Yes	Check that the power supply is within the specified range.
Blocked pump (51) Alarm	The pump is blocked.	No	Dismantle the pump, and remove any foreign matter or impurities preventing the pump from rotating.
Dry running (57) Alarm	No water at the pump inlet or the water contains too much air.	No	Prime and vent the pump before a new start-up. Check that the pump is operating correctly. If not, replace the pump, or call GRUNDFOS SERVICE for assistance.
High motor temperature (64) Alarm	Temperature in stator windings too high.	No	Check the winding resistance according to the MAGNA3 service instructions .
Internal fault (72, 84, 155, 157) Warning/alarm	Internal fault in the pump electronics.	Yes	Replace the pump, or call GRUNDFOS SERVICE for assistance.
Overvoltage (74) Alarm	Supply voltage to the pump too high.	Yes	Check that the power supply is within the specified range.
Communication fault, twin-head pump (77) Warning	Communication between pump heads disturbed or broken.	Yes	Check that the second pump head is powered or connected to the power supply.
Internal sensor fault (88) Warning	The pump is receiving a signal from the internal sensor which is outside the normal range.	Yes	Check that the plug and cable are connected correctly in the sensor. The sensor is located on the back of the pump housing. Replace the sensor, or call GRUNDFOS SERVICE for assistance.
External sensor fault (93) Warning	The pump is receiving a signal from the external sensor which is outside the normal range.	Yes	Does the electrical signal set (0-10 V or 4-20 mA) match the sensor output signal? If not, change the setting of the analog input, or replace the sensor with one that matches the setup. Check the sensor cable for damage. Check the cable connection at the pump and at the sensor. Correct the connection, if required. The sensor has been removed, but the analog input has not been disabled. Replace the sensor, or call GRUNDFOS SERVICE for assistance.

Caution

If the power supply cable is damaged, it must be replaced by the manufacturer, the manufacturer's service partner or a similarly qualified person.

17. Sensor

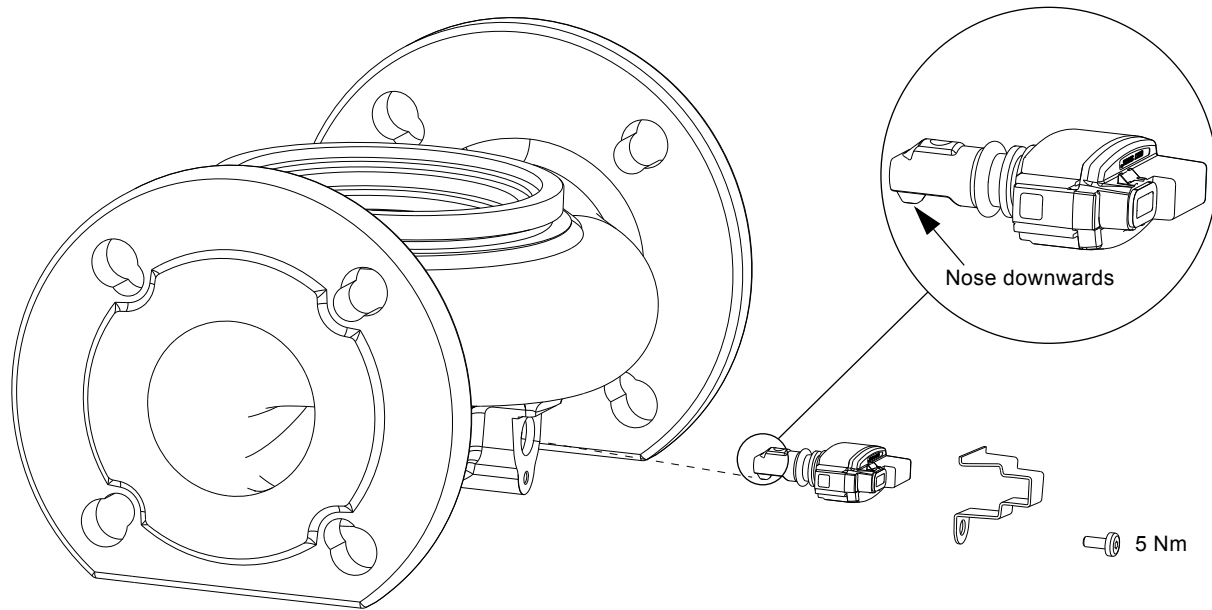

Fig. 39 Correct position of sensor

During maintenance and replacement of the sensor, it is important that the sealing cap is fitted correctly on the sensor housing.

Tighten the screw holding the clamp to 3.7 ft-lbs (5 Nm).



Warning

Before replacing the sensor, make sure that the pump is stopped and that the system is not pressurized.

17.1 Sensor specifications

17.1.1 Pressure

Maximum differential pressure during operation	29 psi / 2 bar / 0.2 MPa
Accuracy +32 to +185 °F (0 to +85 °C)	2 %*
Accuracy +14 to +32 °F and +185 to +266 °F (-10 to 0 °C and +85 to +130 °C)	3 %*

* Full scale.

17.1.2 Temperature

Temperature range during operation	+14 to +266 °F (-10 to +130 °C)
Accuracy	± 3.6 °F (± 2 °C)

18. Accessories



18.1 Grundfos GO Remote

MAGNA3 is designed for wireless communication with the Grundfos GO Remote app. The Grundfos GO Remote app communicates with the pump via radio communication (wireless GENIair).

Note

The radio communication between the pump and Grundfos GO Remote is encrypted to protect against misuse.

The Grundfos GO Remote app is available from Apple AppStore and Android market.

The Grundfos GO Remote concept replaces the Grundfos R100 remote control. This means that all products supported by the R100 are supported by Grundfos GO Remote.

Grundfos GO Remote can be used for the following:

- Reading of operating data.
- Reading of warning and alarm indications.
- Setting of control mode.
- Setting of setpoint.
- Selection of external setpoint signal.
- Allocation of pump number making it possible to distinguish between pumps that are connected via Grundfos GENIbus.
- Selection of function for digital input.
- Generation of reports (PDF).
- Assist function.
- Multi-pump setup.
- Display of relevant documentation.

For function and connection to the pump, see separate installation and operating instructions for the desired type of Grundfos GO Remote setup.

18.2 Communication

The pump can communicate via the wireless GENIair connection or a CIM module.

This enables the pump to communicate with other pumps and with different types of network solutions.

The Grundfos CIM modules (CIM = Communication Interface Module) enable the pump to connect to standard fieldbus networks.

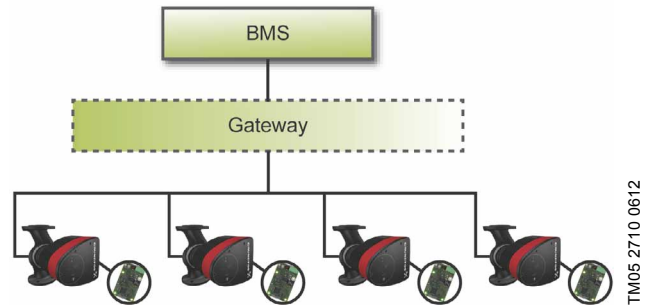

Fig. 40 Building management system (BMS) with four pumps connected in parallel

A CIM module is an add-on communication interface module.

The CIM module enables data transmission between the pump and an external system, for example a BMS or SCADA system.

The CIM module communicates via fieldbus protocols.





Note



A gateway is a device that facilitates the transfer of data between two different networks based on different communication protocols.

The following CIM modules are available:

Module	Fieldbus protocol	Product number
CIM 050	GENIbus	96824631
CIM 100	LonWorks	96824797
CIM 150	PROFIBUS DP	96824793
CIM 200	Modbus RTU	96824796
CIM 250	GSM/GPRS	96824795
CIM 270	GRM	96898815
CIM 300	BACnet MS/TP	96893770
CIM 500	Ethernet	98301408

18.2.1 Description of CIM modules

Module	Fieldbus protocol	Description	Functions
<p>CIM 050</p> 	<p>GENIbus</p> <p>TM05 3812 1612</p>	<p>CIM 050 is a Grundfos communication interface module used for communication with a GENIbus network.</p>	<p>CIM 050 has terminals for the GENIbus connection.</p>
<p>CIM 100</p> 	<p>LonWorks</p> <p>TM05 3813 1612</p>	<p>CIM 100 is a Grundfos communication interface module used for communication with a LonWorks network.</p>	<p>CIM 100 has terminals for the LonWorks connection. Two LEDs are used to indicate the actual status of the CIM 100 communication. One LED is used for indication of correct connection to the pump, and the other is used to indicate LonWorks communication status.</p>
<p>CIM 150</p> 	<p>PROFIBUS DP</p> <p>TM05 3814 1612</p>	<p>CIM 150 is a Grundfos communication interface module used for communication with a PROFIBUS network.</p>	<p>CIM 150 has terminals for the PROFIBUS DP connection. DIP switches are used to set line termination. Two hexadecimal rotary switches are used to set the PROFIBUS DP address. Two LEDs are used to indicate the actual status of the CIM 150 communication. One LED is used for indication of correct connection to the pump, and the other is used to indicate PROFIBUS communication status.</p>
<p>CIM 200</p> 	<p>Modbus RTU</p> <p>TM05 3815 1612</p>	<p>CIM 200 is a Grundfos communication interface module used for communication with a Modbus RTU network.</p>	<p>CIM 200 has terminals for the Modbus connection. DIP switches are used to select parity and stop bits, to select transmission speed and to set line termination. Two hexadecimal rotary switches are used to set the Modbus address. Two LEDs are used to indicate the actual status of the CIM 200 communication. One LED is used for indication of correct connection to the pump, and the other is used to indicate Modbus communication status.</p>
<p>CIM 250</p> 	<p>GSM/GPRS</p> <p>TM05 4432 2212</p>	<p>CIM 250 is a Grundfos communication interface module used for GSM/GPRS communication. CIM 250 is used to communicate via a GSM network.</p>	<p>CIM 250 has a SIM-card slot and an SMA connection to the GSM antenna. CIM 250 also has an internal backup battery. Two LEDs are used to indicate the actual status of the CIM 250 communication. One LED is used for indication of correct connection to the pump, and the other is used to indicate GSM/GPRS communication status.</p> <p>Note: The SIM card is not supplied with CIM 250. The SIM card from the service provider must support data/fax service to use call service from PC Tool or SCADA. The SIM card from the service provider must support GPRS service to use Ethernet service from PC Tool or SCADA.</p>

Module	Fieldbus protocol	Description	Functions
<p>CIM 270</p> 	<p>Grundfos Remote Management</p> <p>TM05 4432 2212</p>	<p>CIM 270 is a Grundfos GSM/GPRS modem used for communication with a Grundfos Remote Management system. It requires a GSM antenna, a SIM card and a contract with Grundfos.</p>	<p>With CIM 270 you have wireless access to your account anywhere, anytime when you have an internet connection, for example via a smartphone, tablet PC, laptop or computer. Warnings and alarms can be sent by e-mail or SMS to your mobile phone or computer. You will get a complete status overview of the entire GRM system. It allows you to plan maintenance and service based on actual operating data.</p>
<p>CIM 300</p> 	<p>BACnet MS/TP</p> <p>TM05 3815 1612</p>	<p>CIM 300 is a Grundfos communication interface module used for communication with a BACnet MS/TP network.</p>	<p>CIM 300 has terminals for the BACnet MS/TP connection. DIP switches are used to set transmission speed and line termination and to select the custom Device Object Instance Number. Two hexadecimal rotary switches are used to set the BACnet address. Two LEDs are used to indicate the actual status of the CIM 300 communication. One LED is used for indication of correct connection to the pump, and the other is used to indicate BACnet communication status.</p>
<p>CIM 500</p> 	<p>Ethernet</p> <p>TM05 8825 2713</p>	<p>CIM 500 is a Grundfos communication interface module used for data transmission between an industrial Ethernet network and a Grundfos product.</p>	<p>CIM 500 supports various industrial Ethernet protocols. CIM 500 is configured via the built-in web server, using a standard web browser on a PC. See the specific functional profile on the DVD-ROM supplied with the Grundfos CIM module.</p>

18.2.2 Grundfos Remote Management

Grundfos Remote Management is an easy-to-install, low-cost solution for wireless monitoring and management of Grundfos products. It is based on a centrally hosted database and a web server with wireless data collection via GSM/GPRS modem. The system only requires an internet connection, a web browser, a GRM modem and an antenna as well as a contract with Grundfos allowing you to monitor and manage Grundfos pump systems. You have wireless access to your account anywhere, anytime when you have an internet connection, for example via a smartphone, tablet PC, laptop or computer. Warnings and alarms can be sent by e-mail or SMS to your mobile phone or computer.

For GRM contract, contact your local Grundfos company.

18.2.3 Reuse of CIM modules

A CIM module in a CIU unit used together with GRUNDFOS MAGNA can be reused in MAGNA3. The CIM module has to be re-configured before it is used in a MAGNA3 pump. Contact your nearest Grundfos company.

Application	Description	Product number
CIM 270	Grundfos Remote Management (requires a contract with Grundfos and a SIM card).	96898815
GSM antenna for roof-mounting	Antenna for use on top of metal cabinets. Vandal-proof. 2-metre cable. Quad band (global use).	97631956
GSM antenna for desk-mounting	Antenna for general-purpose application, for example inside plastic cabinets. To be fixed with the double-adhesive tape supplied. 4-metre cable. Quad band (global use).	97631957

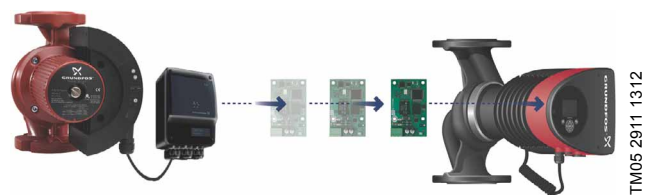

Fig. 41 Reuse of CIM module

18.3 Fitting the CIM module



Warning

Before fitting the module, switch off the power supply. Make sure that the power supply cannot be accidentally switched on.

Step	Action	Illustration
1	Remove the front cover from the control box.	
2	Fit the CIM module as illustrated and click it on.	
3	Fit and tighten the screw holding the CIM module and secure the earth connection.	
4	For connection to fieldbus networks, see separate installation and operating instructions for the desired CIM module.	

TM05 2875 0912

TM05 2914 1112

TM05 2912 1112

TM05 2913 1112

19. Technical data

Supply voltage

See Pump Nameplate for Rated Supply Voltage:

1 x 115 V ± 10 %, 50/60 Hz, PE.

1 x 208-230 V ± 10 %, 50/60 Hz, PE.

Motor protection

The pump requires no external motor protection.

Enclosure class

Enclosure Type 2.

Insulation class

F.

Relative air humidity

Maximum 95 %.

Ambient temperature

+32 °F to +104 °F (0 °C to +40 °C).

During transport: -40 °F to +158 °F (-40 °C to +70 °C).

Temperature class

TF110 (EN 60335-2-51).

Liquid temperature

Continuously: +14 °F to +230 °F (-10 °C to +110 °C).

Stainless-steel pumps in domestic hot-water systems:

In domestic hot-water systems, we recommend to keep the liquid temperature below +150 °F (+65 °C) to eliminate the risk of lime precipitation.

System pressure

The maximum permissible system pressure is stated on the pump nameplate:

175 psi (12 bar).

Inlet pressure

Recommended inlet pressures:

Single-head pumps:

- Min. 1.5 psi / 0.10 bar / 0.01 MPa at +167 °F (+75 °C)
- Min. 5 psi / 0.35 bar / 0.035 MPa at +203 °F (+95 °C)
- Min. 9.5 psi / 0.65 bar / 0.065 MPa at +230 °F (+110 °C).

Twin-head pumps:

- Min. 13 psi / 0.90 bar / 0.09 MPa at +167 °F (+75 °C)
- Min. 17.5 psi / 1.20 bar / 0.12 MPa at +203 °F (+95 °C)
- Min. 22 psi / 1.50 bar / 0.15 MPa at +230 °F (+110 °C).

EMC (electromagnetic compatibility)

EN 55014-1:2006, EN 55014-2:1998, EN 61800-3-3:2008 and EN 61000-3-2:2006.

Sound pressure level

The sound pressure level of the pump is lower than 43 dB(A).

Leakage current

The pump mains filter will cause a discharge current to earth during operation. $I_{leakage} < 3.5$ mA.

Consumption when the pump is stopped

1 to 10 W, depending on activity, i.e. reading the display, use of Grundfos GO Remote, interaction with modules, etc.

Input/output communication

Two digital inputs	External potential-free contact. Contact load: 5 V, 10 mA. Screened cable. Loop resistance: Maximum 130 Ω.
Analog input	4-20 mA (load: 150 Ω). 0-10 VDC (load: 78 kΩ).
Two relay outputs	Internal potential-free changeover contact. Maximum load: 250 V, 2 A, AC1. Minimum load: 5 VDC, 20 mA. Screened cable, depending on signal level.

cos φ

MAGNA3 has a built-in active PFC (Power Factor Correction) which gives a cos φ from 0.98 to 0.99, i.e. very close to 1.

20. Disposal

This product has been designed with focus on the disposal and recycling of materials. The following disposal values apply to all variants of Grundfos MAGNA3 pumps:

- minimum 85 % recycling
- maximum 10 % incineration
- maximum 5 % depositing.

Values in percent of total weight.

This product or parts of it must be disposed of in an environmentally sound way according to local regulations.

Subject to alterations.

GRUNDFOS Kansas City

17100 West 118th Terrace
Olathe, Kansas 66061
Phone: (913) 227-3400
Fax: (913) 227-3500

www.grundfos.us

GRUNDFOS Canada

2941 Brighton Road
Oakville, Ontario L6H 6C9 Canada
Phone: +1-905 829 9533
Telefax: +1-905 829 9512

www.grundfos.ca

GRUNDFOS México

Boulevard TLC No. 15
Parque Industrial Stiva Aeropuerto
C.P. 66600 Apodaca, N.L. México
Phone: 011-52-81-8144 4000
Fax: 011-52-81-8144 4010

www.grundfos.mx

L-MAG-TL-09

98459408 0614

ECM: 1133339

© Copyright Grundfos Holding A/S

The name Grundfos, the Grundfos logo, and be think innovate are registered trademarks owned by Grundfos Holding A/S or Grundfos A/S, Denmark. All rights reserved worldwide.